

HAVELLS

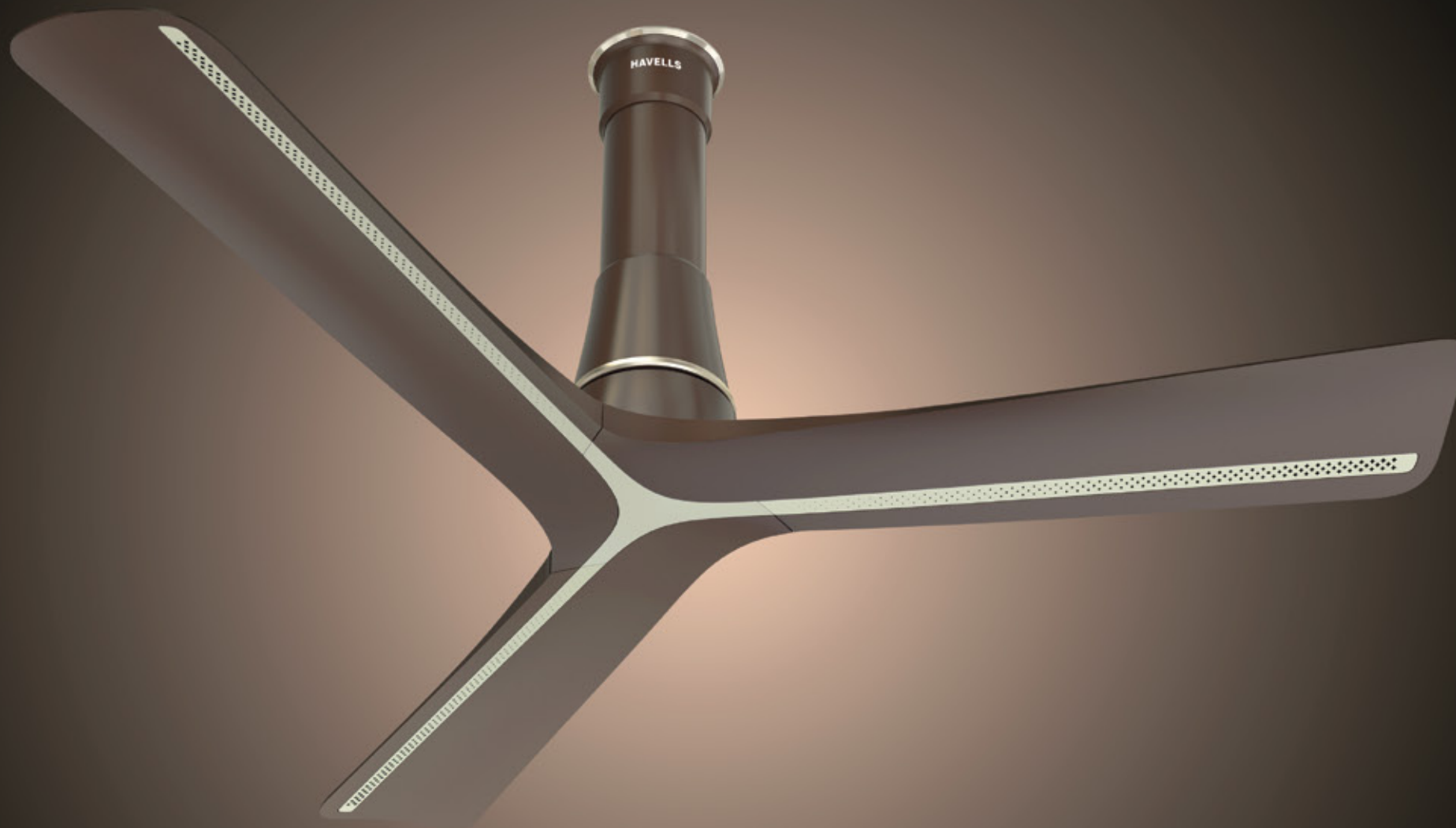

LOOK UP

TO GREAT DESIGNS | TO WIDE RANGE | TO ENERGY SAVINGS



LOOK UP

TO GREAT DESIGNS | TO WIDE RANGE | TO ENERGY SAVINGS

FAN PLANT

Havells world class manufacturing plant is India's most modern and integrated unit for electric fans in the country. Located in Haridwar, Uttarakhand, the plant is equipped with state-of-the-art technology. The Company uses 4.0 techniques to deliver products that meet the highest standards. The plant is smart and tech-savvy and uses automated processes like CNC machines for motor winding and other operations, advanced conveyor assembly lines with computerized testing facilities.

With the 'Make in India' concept at its heart, Havells manufactures a wide range of innovative and premium fans for domestic and international markets. The company keeps upgrading its facilities constantly, to be in line with the ever-changing market dynamics. Let the wide range of Havells Fans bring in a new change and add value to your lifestyle.

HARIDWAR, UTTARAKHAND



ABOUT US

Redefining the modern homes with innovation and excellence

Havells is at the forefront of transforming modern living spaces by offering innovative solutions that elevate everyday experiences. With a deep understanding of consumer needs, the company has expanded its footprint across every aspect of home life, creating environment that are not only functional but also comfortable, stylish and future-ready. To make these solutions accessible, Havells leverages an extensive distribution network encompassing 18,000 dealers, over 1,000 exclusive brand stores, intensifying presence in modern retail, e-commerce and quick commerce.

The company's portfolio includes power brands like Havells, Havells Crabtree, Lloyd, REO, Havells Studio and Standard each designed to cater to the unique demands of today's consumers.

Anchored in the 'Make in India' initiative, Havells operates 16 cutting-edge manufacturing facilities across India, producing 90% of its products in-house. At the forefront of Havells product evolution lies its Customer Experience & Designs (CXD) Studio, where creativity and user-centric design converge. This is complemented by its Centre for Research & Innovation (CRI), supported by four advanced R&D centres, enabling Havells to consistently deliver products that are both functional and visually compelling.

Driven by a commitment to innovation, quality and design, the company also upholds sustainable practices throughout its operations, including eco-friendly manufacturing processes and energy-efficient product design, contributing to a greener and more sustainable future.



CORPORATE OFFICE, NOIDA



State-of-the-Art Manufacturing Unit



Customer Experience & Design



Industry 4.0 Process



Center For Research & Innovation



16 Manufacturing Units

~18000 Strong Dealer Network

4 Research Centres

48 Offices

AWARDS



CONTENT

BLDC+
UNDERLIGHT
FANS
14

BLDC+
FANS
38

SPECIAL
FINISH FANS
66

DECORATIVE
FANS
72

REGULAR
FANS
90

TABLE
FANS
100

PEDESTAL
FANS
108

WALL
FANS
126

PERSONAL
FANS
140

VENTIL AIR
FANS
148

INDUSTRIAL
FANS
166

BLDC+
UNDERLIGHT
FANS

BLDC+
FANS

SPECIAL
FINISH FANS

DECORATIVE
FANS

REGULAR
FANS

TABLE
FANS

PEDESTAL
FANS

WALL
FANS

PERSONAL
FANS

VENTILAIR
FANS

INDUSTRIAL
FANS

FAN SELECTION GUIDE

Ceiling fan should be selected basis to room size, type, purpose, ambience hues and style preferences.

Sweep Size – Sweep refers to the diameter of the fan. Choosing appropriate sweep size is crucial for optimum air circulation and energy efficiency.

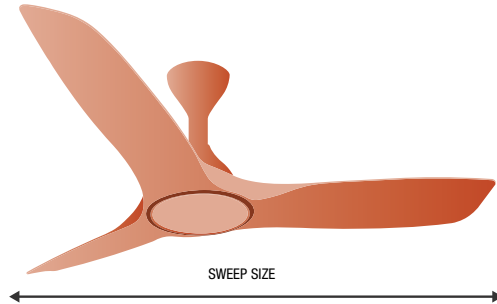

Sweep – Room Sizes Chart

It is advisable to select desired fan sweep as per the given room size chart for better comfort.

Sweep Size	Room Size	Room Type
600 mm	1.2 m x 2 m	Small cabin, Utility, Veranda, Balcony, Washroom, etc.
900 mm	3 m x 3 m	Guest Bedroom, Study room, etc.
1200 mm	3.6 m x 4 m	Master Bedroom, Living Room, Dining Hall, etc.
1400 mm	4.2 m x 4.8 m	Large Halls, Workspace, etc.

Determining Ideal Number of Fans Based on Room Layout

Refer to below room layout for determining ideal number of fans.

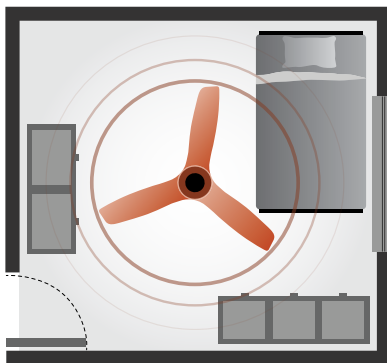

Linear room layout

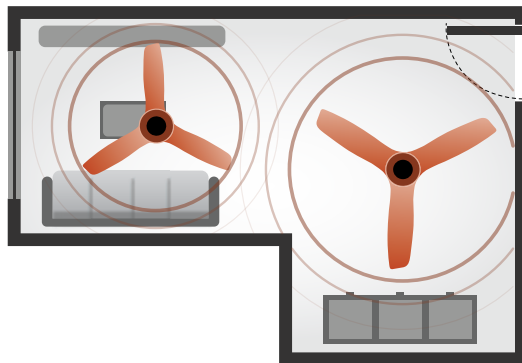

Non-Linear room layout

Type of Room



Dusty Rooms require constant maintenance. Choose Liquid paint with anti-dust coating.



Quiet spaces such as work rooms, study rooms need silent fans preferably with an under light feature.



Smart Spaces look better with slim fans with under light and smart features like Direct Voice Control, IOT enabled fans for a smart look.

Room Style and Ambient colour

Match the colour of the fan to suit the ceiling and furniture for a balanced look. Choosing a dark-coloured fan can accentuate your ceiling, while light coloured fans will make the room look silent.



Modern interiors are best paired with solid coloured BLDC fans for a smart look.



Traditional homes shines well with decorative trims and prints on fan blades / show cap.



Monochrome fans add an elegant look in brightly lit / coloured spaces.

FAN SELECTION GUIDE

Important Tips

A. When choosing a fan, do not restrict to blade count and RPM values only. Look for the Air Delivery (AD) value, which measures airflow within set amount of wattage. A higher AD value ensures better airflow and circulation.

It is advisable to select desired fan sweep as per the given room size chart for better comfort.

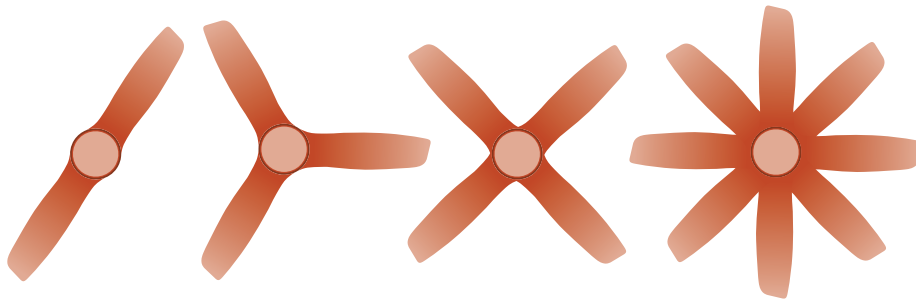
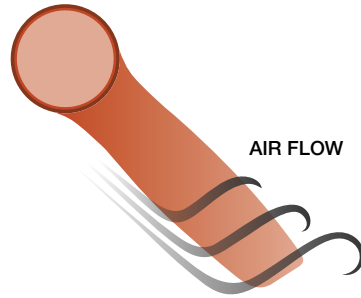

B. Having multiple blades doesn't guarantee more cooling or air circulation. Fan blades are designed to provide more air or less air circulation based on the type of fan model. More blades reflect "traditional" vibe while fewer blades give an "advanced" appearance.

Installation Guide

Optimal Height between Floor and Ceiling Fan

To have optimum air circulation, bottom of the floor should be minimum 2.1 m - 2.4 m from the floor. If room height is more than 2.4 m, add 15.24 cm rod to the downrod, for every 30.5 cm of the ceiling height.

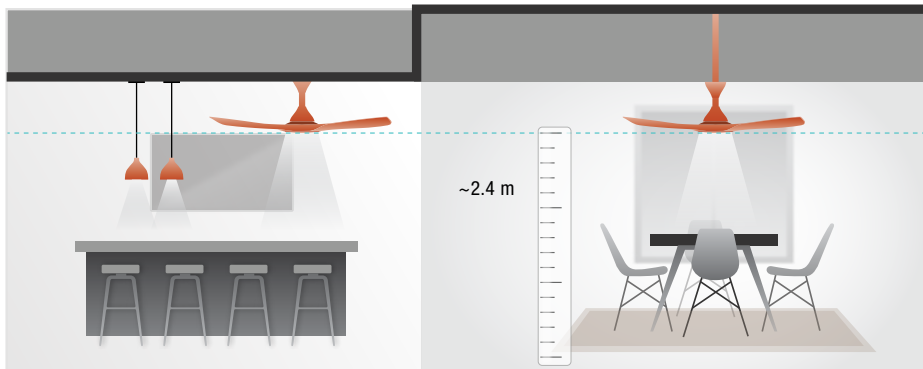

Optimal Height Between Floor and Ceiling Fan

Star Rating System

All Havells ceiling fans are compliant with the standards laid down by Indian Bureau of Energy Efficiency. It is indicated by BEE Star Rating (service value) of the product and is mostly marked on the top zones on our Fans and Packaging. Higher the service value, better is the star rating. It helps customers to make an informed decisions while purchasing.

$$\text{Service Value} = \frac{\text{Air Delivery (m}^3\text{/min)}}{\text{Wattage (W)}}$$



FOLLOWING ARE THE MINIMUM SERVICE VALUE OFFERED BY HAVELLS FOR DIFFERENT SWEEP SIZES.

Fan Sweep Size	Minimum Air Delivery	Minimum Service Value
600 mm	110 m ³ /min	2.0
900 mm	140 m ³ /min	3.6
1200 mm	220 m ³ /min	4.5
1400 mm	240 m ³ /min	4.5

ENERGY EFFICIENCY AND SAVINGS

	2 Stars	3 Stars	4 Stars	5 Stars	6 Stars
Electricity Bill Per Annum	₹ 2 900.00	₹ 2 500.00	₹ 2 350.00	₹ 2 250.00	₹ 1 750.00
Annual Savings* Compared to "No Rating"	₹ 1 440.00	₹ 1 725.00	₹ 1 950.00	₹ 2 000.00	₹ 2 500.00

*Annual Saving as compared to non-star rated fan.

10

REASONS TO
UPGRADE TO
HAVELLS

BLDC+
FANS

1



**DIRECT
VOICE
COMMAND**

No Internet Required
Voice Activated Fan

2

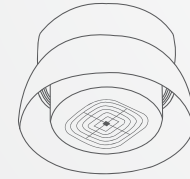

**HAVELLS 1ST
ALL WEATHER
FAN**

With Room Heater

6



**ARTIFICIALLY
INTELLIGENT
FANS**

India's Largest Range of
Artificially Intelligent Fans

7

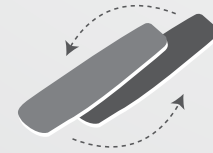

**REVERSIBLE
WOODEN
BLADES**

3

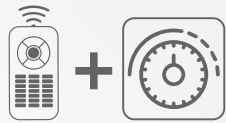

DUAL CONTROL

With Remote & Regulator

4



SILENT OPERATION

5



REVERSE ROTATION

In All BLDC Fans For Warm Air in Winter

8



India's Largest Range of

5 STAR RATED UNDERLIGHT FANS

9



SMART CONTROL

Bluetooth enabled

10



MOST EFFICIENT EPIC SERIES

Lowest Power Consumption of 30 W
Upto 50 %* Energy Saving
Best Service Value of 7.5

*Energy saving as compared with 1 star rated fans

LOOK UP TO STEALTH VOICE BLDC+ FAN

+  **DIRECT VOICE COMMAND**
NO INTERNET REQUIRED



Hello Havells!
Switch On The Fan

 NO BLUETOOTH |  NO SMART PHONE



UPTO 50%*
ENERGY SAVINGS

Range of Voice Command fans are available

*Energy saving as compared with 1 star rated fans.

LOOK UP TO CRISTA UNDERLIGHT BLDC+ FAN

+  **DUAL UNDERLIGHT**



UPTO 50%^{*}
ENERGY SAVINGS

Range of IoT enabled Fans available

*Energy saving as compared with 1 star rated fans.

Connect  **within your home**

Connect from  **outside your home**



LOOK UP TO
ALBUS SMART SENSE
BLDC+FAN

+  REVERSIBLE WOODEN BLADE



All technology with Smart Sensing for Room Temperature and Humidity



Smart Sense for
auto speed adjustment



UPTO 50%*
ENERGY SAVINGS

Range of smartsense fans are available

*Energy saving as compared with 1 star rated fans.

LOOK UP TO EPIC PLUS BLDC+ FAN

+  &  **DUAL CONTROL
REMOTE & REGULATOR**



UPTO 50%*
ENERGY SAVINGS

Range of Remote & Regulator compatible fans available

*Energy saving as compared with 1 star rated fans.



HAVELLS

LOOK UP TO

BLDC +
UNDERLIGHT
FANS



HAVELLS



NEOMA UNDERLIGHT



Underlight with Color changing tech



Aerodynamic ABS Blades



Reverse Rotation



Low Noise



RF remote control for all direction sensing



Free Installation



- Mood Changing Underlight with Dimmable & Tunable technique
- Aerodynamic ABS blades for silent operation and better air delivery
- Wooden finishes on the blades and electroplated canopies
- Breeze, Sleep and Mop modes. Timer setting upto 8 hours
- Reverse Rotation for circulating warm air during winter

STAR RATING	SWEEP	POWER INPUT	SPEED	AIR DELIVERY
	1200 mm	35 W	300 r/min	226 m ³ /min



Nickel Pine Wood



Nickel Walnut



Matt Black Mist



Matt Black Champagne



BLDC+

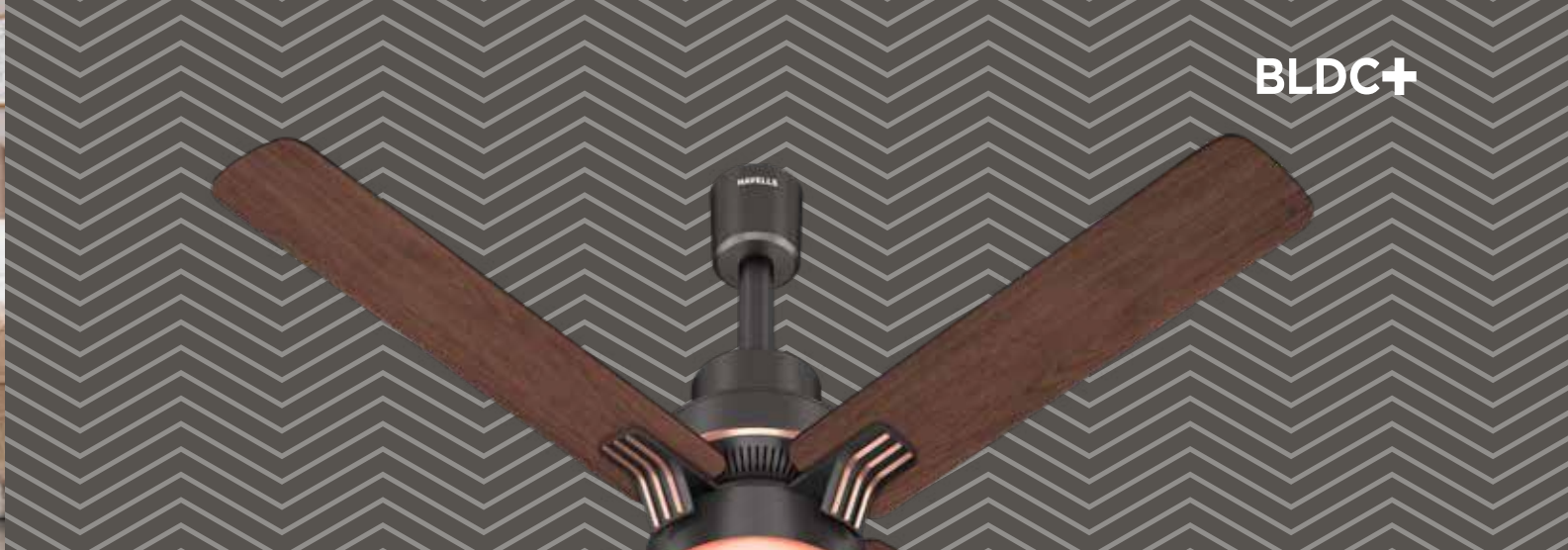

FLORETTE BLDC ALL WEATHER UNDERLIGHT

USE YOUR FAN IN WINTERS TOO!

Smoke Brown Walnut



Smoke Brown Pinewood



Underlight with Color changing tech

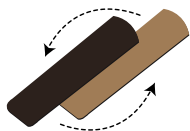

Reversible Blade



Reverse Rotation



Low Noise



RF remote control for all direction sensing



Free Installation



Integrated PTC heater with soothing Amber LED light



- In-built PTC heater with high energy efficiency and Zero Oxygen combustion to maintain freshness
- Reverse Rotation for circulating warm air during winter
- Side changeable reversible premium MDF blades to suit room decor
- Soft start mood Changing Ambient Underlight with Dimmable & Tunable technique
- Breeze, Sleep and Mop modes. Timer setting upto 8 hours

STAR RATING	SWEEP	POWER INPUT	SPEED	AIR DELIVERY
	1320 mm	40 W	270 r/min	245 m ³ /min



NOTE : Power consumption of heater is 700 W



HAVELLS



ALBUS SMART SENSE UNDERLIGHT

Smoke Brown Walnut



Underlight with Color changing tech



RF remote control for all direction sensing



Low Noise



Free Installation



Auto Humidity & Temperature Sensing



Reverse Rotation

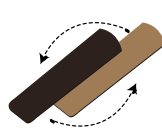

Reversible Blade



- Automatic speed adjustment by Smart Sensing for Humidity and Temperature
- Mood Changing Underlight with Dimmable & Tunable technique
- Side changeable reversible premium MDF blades
- Reverse Rotation for circulating warm air during winter
- Breeze, Sleep and Mop modes. Timer setting upto 8 hours

STAR RATING	SWEEP	POWER INPUT	SPEED	AIR DELIVERY
	1320 mm	40 W	270 r/min	245 m ³ /min



Smoke Brown Pinewood

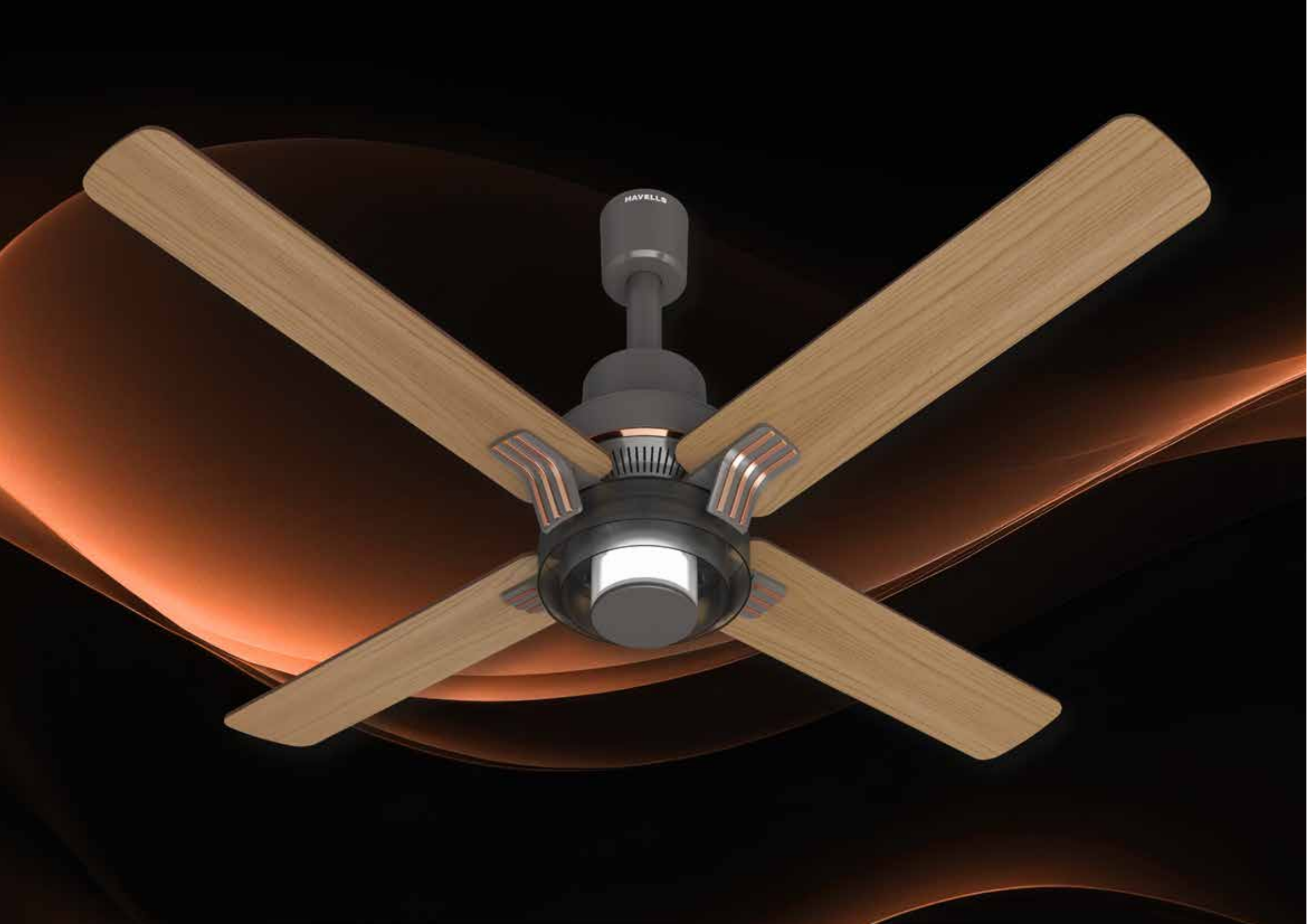



FLORETTE SMART SENSE UNDERLIGHT



Underlight with Color changing tech



RF remote control for all direction sensing



Low Noise



Free Installation



Auto Humidity & Temperature Sensing



Reverse Rotation

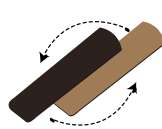

Reversible Blade



- Automatic speed adjustment by Smart Sensing for Humidity and Temperature
- Mood Changing Underlight with Dimmable & Tunable technique
- Side changeable reversible premium MDF blades
- Reverse Rotation for circulating warm air during winter
- Breeze, Sleep and Mop modes. Timer setting upto 8 hours

STAR RATING	SWEEP	POWER INPUT	SPEED	AIR DELIVERY
	1320 mm	40 W	270 r/min	245 m ³ /min



Smoke Brown Pinewood

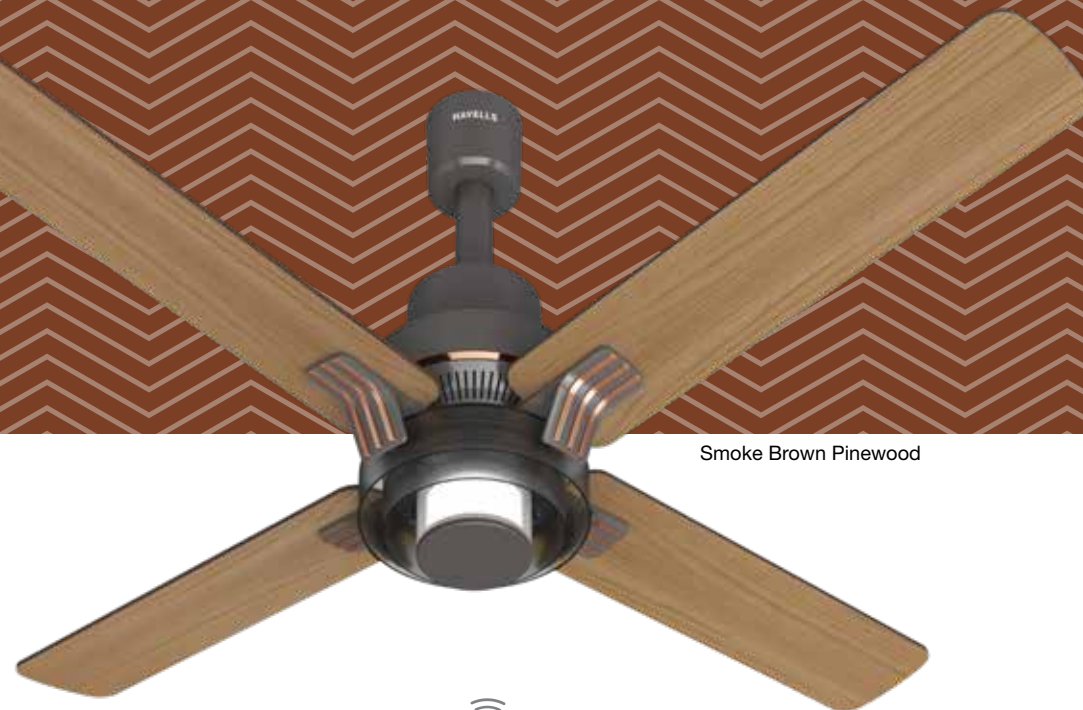

Smoke Brown Walnut





MOMENTA UNDERLIGHT (IOT)

Connect within your home

Connect from outside your home



Underlight with Color changing tech



Aerodynamic ABS Blades in wood Finish



RF remote control for all direction sensing



Low Noise



Free Installation



Smoke Brown Walnut



- Control your IOT enabled fan from home & outside home
- Mood Changing Underlight with Dimmable & Tunable technique
- Aerodynamic wood finish ABS blades for high air delivery
- Breeze, Sleep and Mop modes. Timer setting upto 8 hours

STAR RATING	SWEEP	POWER INPUT	SPEED	AIR DELIVERY
	1200 mm	40 W	280 r/min	245 m ³ /min



Smoke Brown Pinewood





CRISTA BLDC UNDERLIGHT (IOT)

Connect within your home

Connect from outside your home



Underlight with Color changing tech



Aerodynamic ABS blade with winglet design



RF remote control for all direction sensing



Low Noise



Free Installation



Telescopic Canopy



Dual Underlight



Champagne Cola



Pearl White LT Copper



Slate Chrome

- Control your IOT enabled fan from home & outside home
- Mood Changing Outer Underlight with Dimmable & Tunable technique
- Dual LED underlight for comfort and elegance
- Telescopic canopy for adjusting to various ceiling height
- Aerodynamic Winglet blades for superior air delivery
- Breeze and Sleep modes. Timer setting upto 8 hours





STAR RATING	SWEEP	POWER INPUT	SPEED	AIR DELIVERY
	1200 mm	39 W	300 r/min	255 m³/min









STEALTH AIR BLDC UNDERLIGHT

- 
 Free Installation
- 
 Reverse Rotation
- 
 RF Remote control for all direction sensing
- 
 Silent 52 dB Noise Level
- 
 Underlight with Color changing tech

- 
 Aerodynamic ABS Blades
- 
- 
- 

- Mood Changing Underlight with Dimmable & Tunable technique
- Dust & Mark Resistant ABS reinforced blades
- Reverse Rotation for circulating warm air during winter
- Completely Silent Operation with 52 dB* only noise level
- Breeze, Sleep and Mop modes. Timer setting upto 8 hours

STAR RATING	SWEEP	POWER INPUT	SPEED	AIR DELIVERY
	1200 mm	40 W	280 r/min	245 m ³ /min
	900 mm	26 W	400 r/min	145 m ³ /min



Mist



Champagne



Pearl White

NOTE : 900 mm size is available in Pearl White Finish only. *May vary as per surrounding noise.



HAVELLS



STEALTH SLIM UNDERLIGHT



Free Installation



Reverse Rotation



RF Remote control for all direction sensing



Aerodynamic ABS Blades



Silent 52 dB Noise Level



Underlight with Color changing tech

- Mood Changing Underlight with Dimmable & Tunable technique
- Aerodynamic ABS blades for silent operation and high air delivery
- Breeze, Sleep and Mop modes. Timer setting upto 8 hours
- Completely Silent Operation with 52 dB* only noise level
- Reverse Rotation for circulating warm air during winter

STAR RATING	SWEEP	POWER INPUT	SPEED	AIR DELIVERY
	1200 mm	37 W	290 r/min	240 m ³ /min



Oatmeal



Graphite



Stone Grey



Satin White

*May vary as per surrounding noise.





CERA BLDC UNDERLIGHT



Telescopic Height



Reverse Rotation

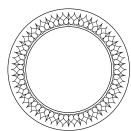

Special carving design



Halo Ambient Light



RF remote control for all direction sensing



380 Revolutions Per Minute Hi Speed Mode



- Unique transparent circular designer trims with halo lighting effect
- Balanced & smart design that provides easy cleaning
- Reverse Rotation for circulating warm air during winter
- Breeze, Sleep, Boost and Mop modes. Timer setting upto 8 hours



Slate



Champagne



Pearl White



Mist

STAR RATING	SWEEP	POWER INPUT	SPEED	AIR DELIVERY
	1200 mm	35 W	350 r/min	226 m ³ /min







BLDC+



Matt Black

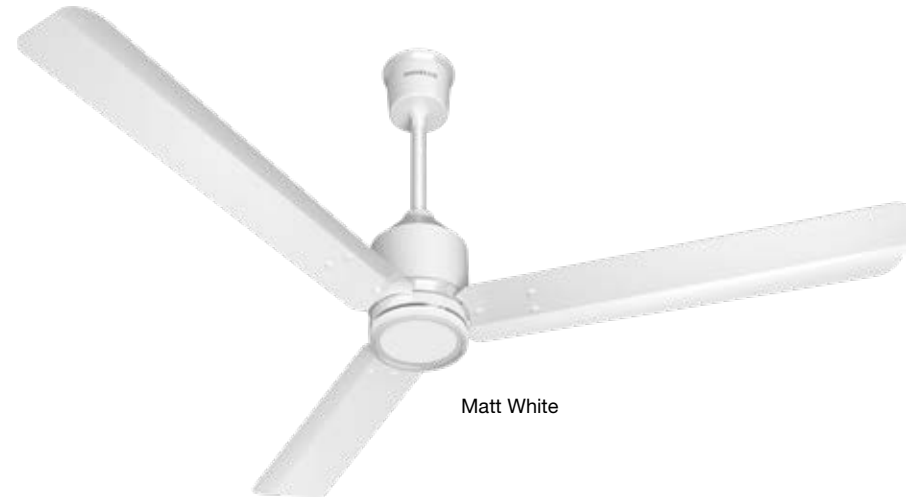

Matt White

NEON UNDERLIGHT



Reverse Rotation



RF Remote control for all direction sensing



Sleek & Minimalistic Design



Underlight with Color changing tech



380 Revolutions Per Minute Hi Speed Mode

- Mood Changing Underlight with Dimmable & Tunable technique
- Sleek & Minimalistic Design to enhance room decor
- Reverse Rotation for spreading warm air during winter
- Breeze, Sleep, Boost and Mop modes. Timer setting upto 8 hours

STAR RATING	SWEEP	POWER INPUT	SPEED	AIR DELIVERY
	1200 mm	30 W	350 r/min	220 m ³ /min







BLDC+



Smoke Brown

EPIC UNDERLIGHT



Reverse Rotation



RF Remote control for all direction sensing



Sleek & Minimalistic Design



Underlight with Color changing tech



380 Revolutions Per Minute Hi Speed Mode

- Mood Changing Underlight with Dimmable & Tunable technique
- Reverse Rotation for circulating warm air during winter
- Most Efficient Fan with Lowest power consumption of 30 W, Upto 50%* Energy Saving & Best Service Value of 7.5
- Peak Performance with speed 380 Revolutions Per Minute and air delivery 235 m³/min on Boost Mode
- Breeze, Sleep, Mop and Boost modes. Timer setting upto 8 hours

STAR RATING	SWEEP	POWER INPUT	SPEED	AIR DELIVERY
	1200 mm	30 W	350 r/min	225 m ³ /min



Denim Blue



Stone Grey



Elegant White

*Energy saving as compared with 1 star rated fans.



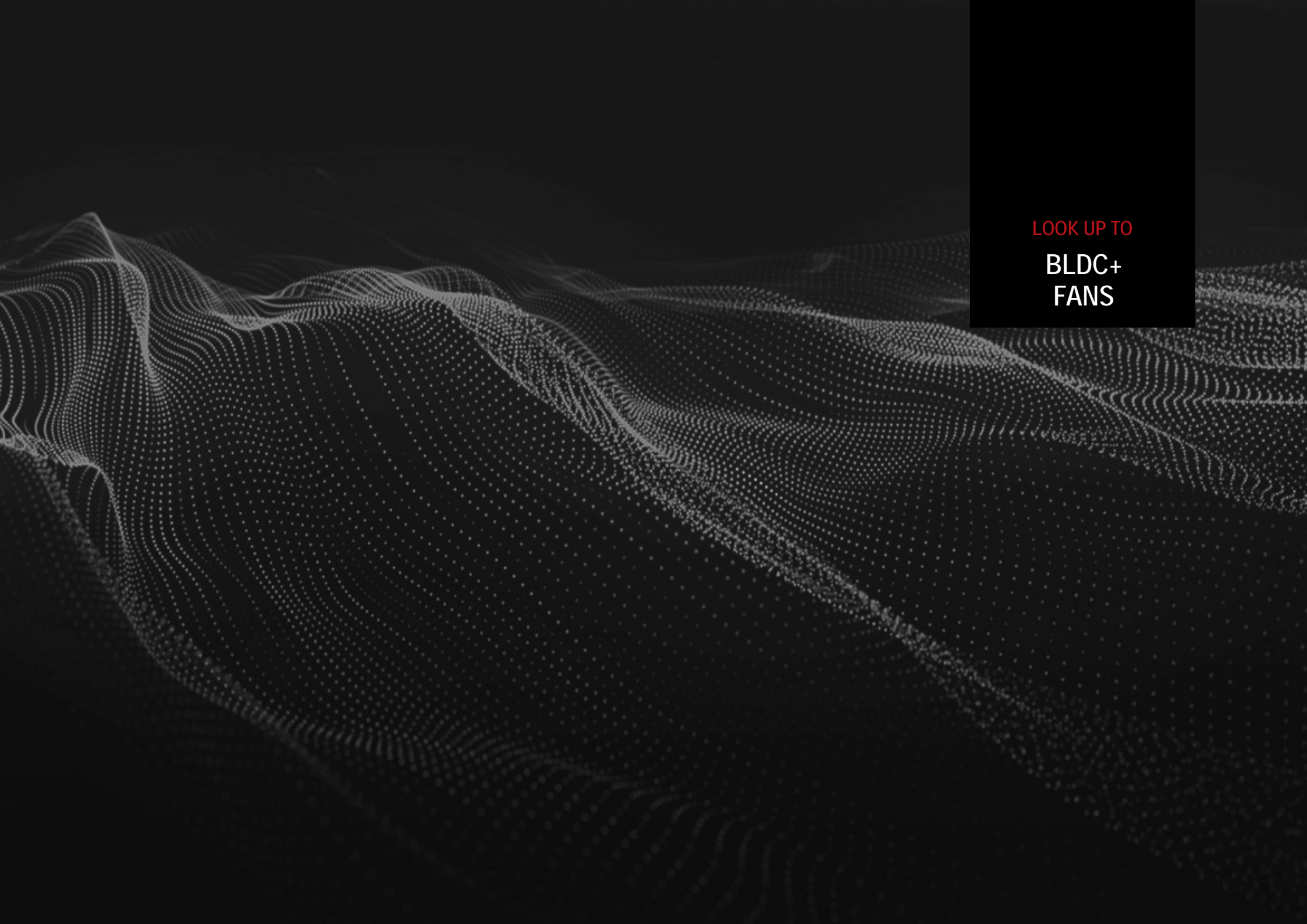

LOOK UP TO

BLDC+
FANS

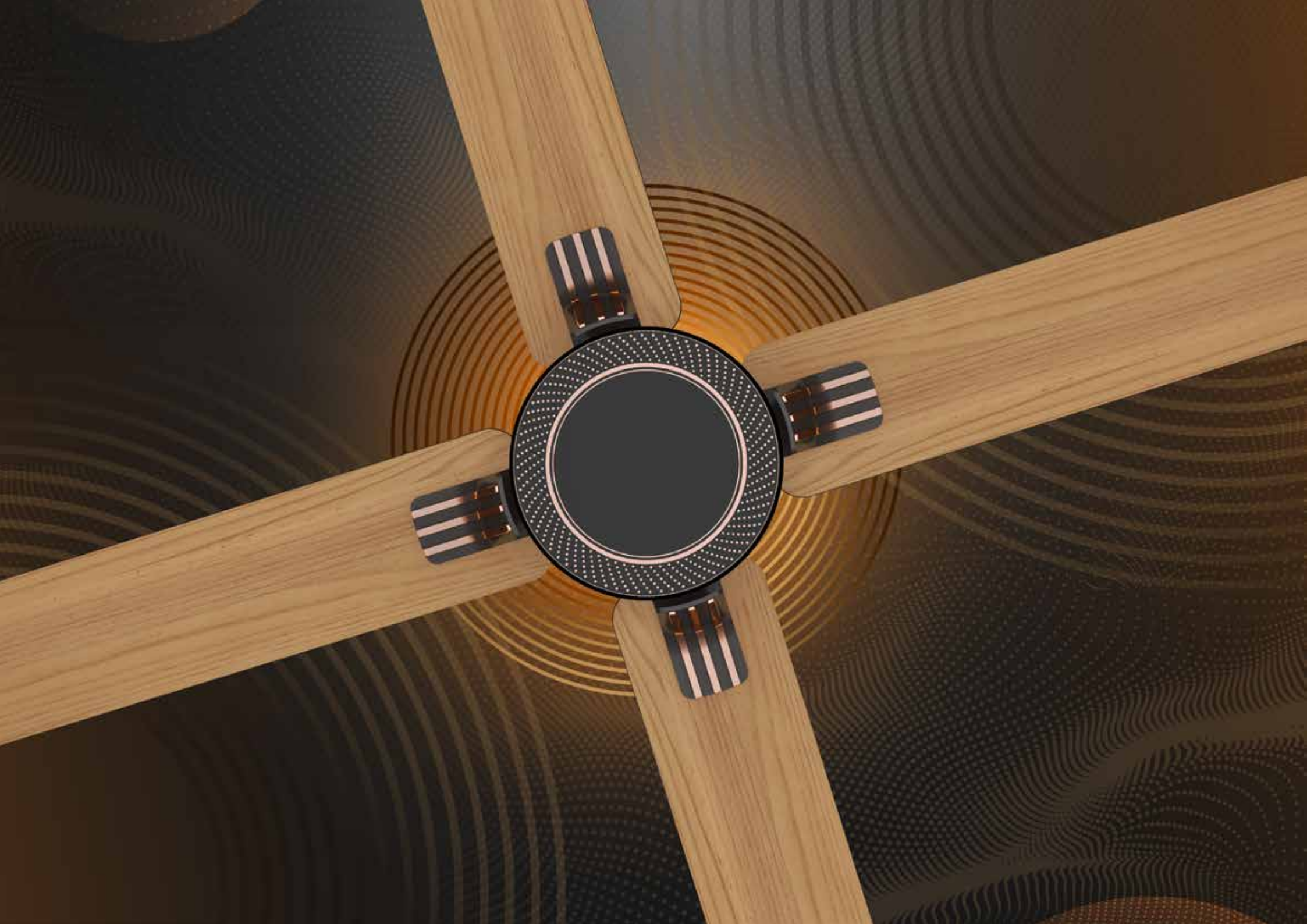



BLDC+

FLORETTE

BLDC



RF remote control for all direction sensing



Low Noise



Free Installation



Reverse rotation

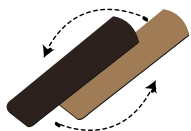

Reversible Blade



- Side changeable Premium MDF blades to suit home decor
- Reverse Rotation for circulating warm air during winter
- Breeze, Sleep and Mop modes. Timer setting upto 8 hours

STAR RATING	SWEEP	POWER INPUT	SPEED	AIR DELIVERY
	1320 mm	37 W	270 r/min	240 m ³ /min



Smoke Brown Walnut



Smoke Brown Pinewood



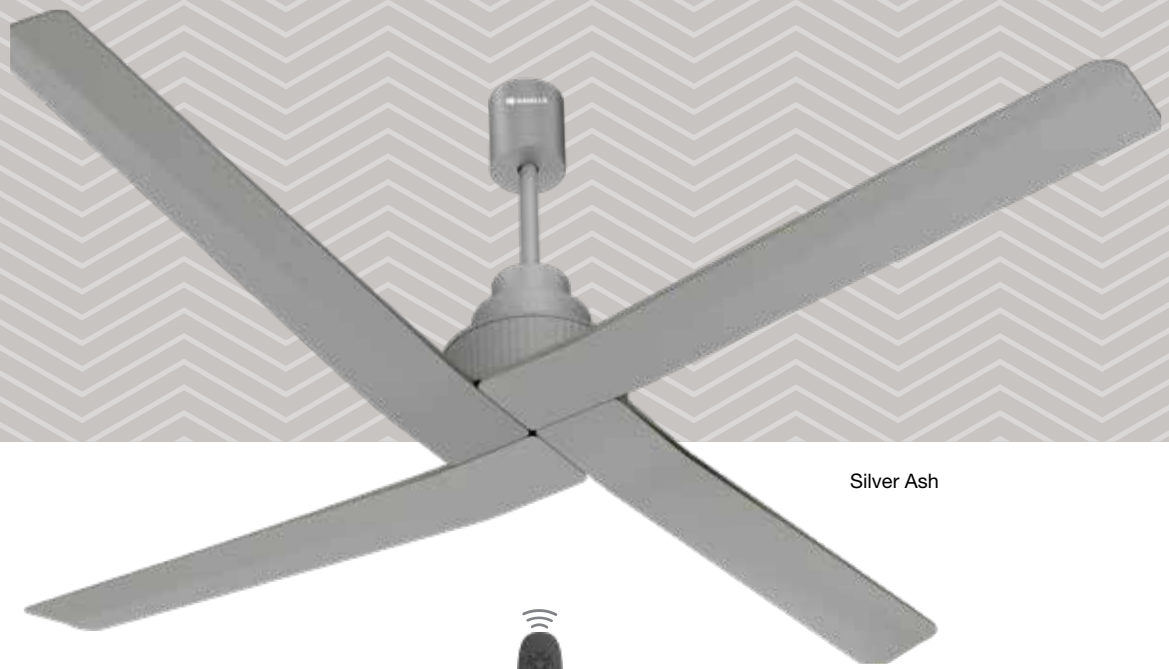

Silver Ash

AMAYA BLDC



Unique 4 blade
Rivet-less design



RF remote control for
all direction sensing



Low
Noise



Free
Installation



Reverse
Rotation



Satin White

- Italian Rivet-less design with Premium PU Finish
- Compound ABS blades for high strength, silent operation and better air delivery
- Breeze, Sleep and Mop modes. Timer setting upto 8 hours
- Reverse Rotation for circulating warm air during winter

STAR RATING	SWEEP	POWER INPUT	SPEED	AIR DELIVERY
	1400 mm	37 W	270 r/min	250 m³/min





HAVELLS



BLDC+

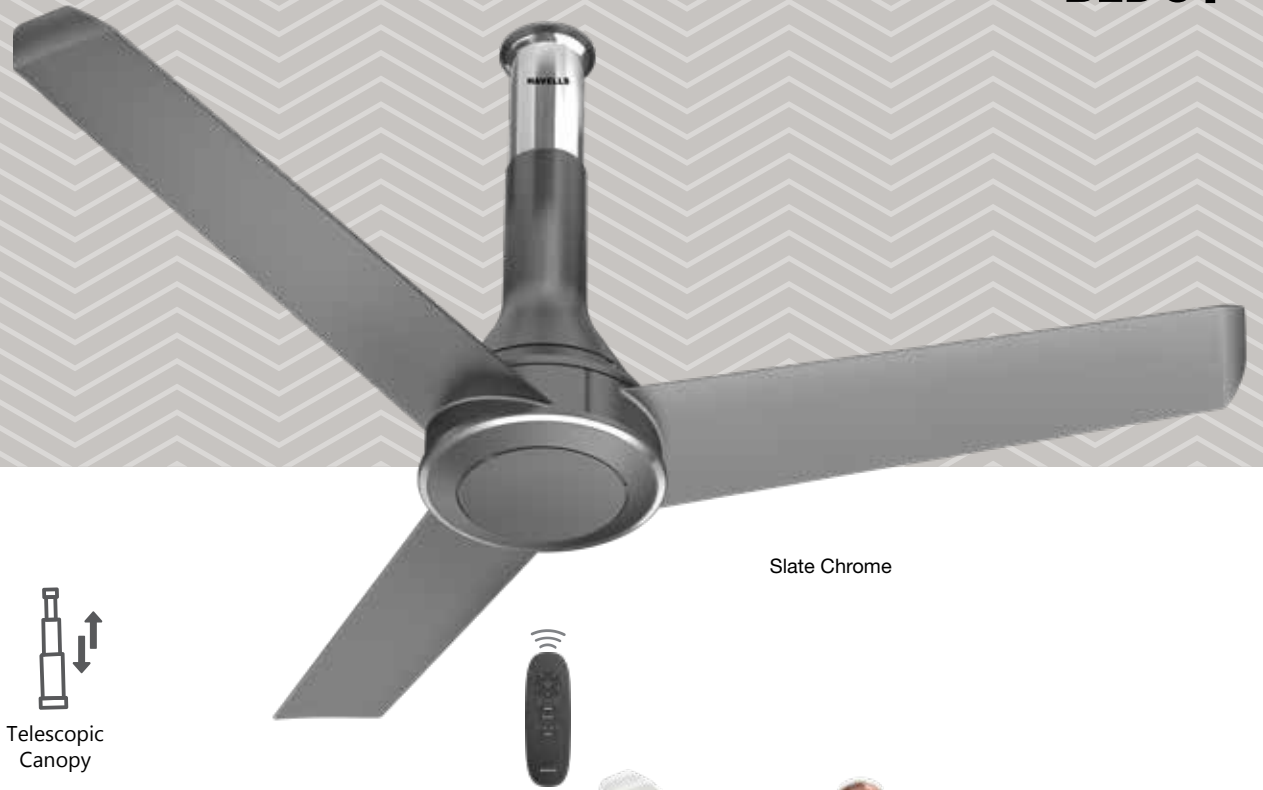

Slate Chrome

CRISTA BLDC



Aerodynamic blades with Winglet Design



RF remote control for all direction sensing



Low Noise



Free Installation

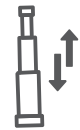

Telescopic Canopy



Reverse Rotation



- Aerodynamic Winglet blades for Superior Air Delivery
- Telescopic canopy for adjusting to various ceiling heights
- Reverse Rotation for circulating warm air during winter
- Breeze, Sleep and Mop modes. Timer setting upto 8 hours

STAR RATING	SWEEP	POWER INPUT	SPEED	AIR DELIVERY
	1200 mm	37 W	300 r/min	250 m ³ /min



Pearl White LT Copper

Champagne Cola





INVENGO LX BLDC



Free Installation



Telescopic Canopy



Reverse rotation



Low Noise



RF remote control for all direction sensing



Aerodynamic ABS blade with seamless IMD trim



100% COPPER WIRE WINDING MOTOR

- Phantom Tech: Invisible Motor Design with IMD pattern
- Unique seamless body design with Premium Metallic Finish
- Aerodynamic blades for high air delivery
- Reverse Rotation for circulating warm air during winter
- Breeze, Sleep and Mop modes. Timer setting upto 8 hours

STAR RATING	SWEEP	POWER INPUT	SPEED	AIR DELIVERY
	1200 mm	35 W	280 r/min	230 m ³ /min



Satin Brown



Satin Cream



Satin Dusk



Satin Mist



Satin White



**“Hello Havells
Switch On”**



STEALTH AIR

BLDC VOICE 3.0

Pearl White



Direct Voice Command



No Internet Required



RF remote control for all direction sensing



Silent 52 dB Noise Level



Free Installation



Reverse rotation



Aerodynamic ABS Blades

- Direct Voice Controlled Fan with Innovative AI Technology
- Talk To Your Fan Directly. No Internet / Wifi / Smart Phone or Bluetooth Required
- Hindi & English voice recognition with 29 commands
- Reverse Rotation for circulating warm air during winter
- Breeze, Sleep and Mop modes. Timer setting upto 8 hours
- Completely Silent Operation with 52 dB* only noise level

STAR RATING	SWEEP	POWER INPUT	SPEED	AIR DELIVERY
	1200 mm	37 W	280 r/min	240 m ³ /min



Scan to Know Voice Cammands

*May vary as per surrounding noise.



STEALTH AIR WOOD BLDC



Free Installation



Reverse Rotation



Silent 52 dB Noise Level



RF remote control for all direction sensing



- Aerodynamic Blades for Superior Air Delivery
- Breeze, Sleep and Mop modes. Timer setting upto 8 hours
- Reverse Rotation for circulating warm air during winter
- Completely Silent Operation with 52 dB* only noise level

STAR RATING	SWEEP	POWER INPUT	SPEED	AIR DELIVERY
	1200 mm	37 W	280 r/min	240 m ³ /min
	1200 mm	40 W	280 r/min	245 m ³ /min
	900 mm	26 W	400 r/min	145 m ³ /min

NOTE : 900 mm & 1200 mm 4 star variants are available without remote. *May vary as per surrounding noise.



Walnut Cola



Pinewood Cola





STEALTH NEO BLDC



Premium PU finish
ABS Blades



RF remote control for
all direction sensing



Silent 52 dB
Noise Level



Free
Installation



Reverse
Rotation



Mist Wood



Pearl White Wood

- Aerodynamic Blades for Superior Air delivery
- Breeze, Sleep and Mop modes. Timer setting upto 8 hours
- Reverse Rotation for circulating warm air during winter
- Completely Silent Operation with 52 dB* only noise level

STAR RATING	SWEEP	POWER INPUT	SPEED	AIR DELIVERY
	1200 mm	37 W	280 r/min	240 m ³ /min



*May vary as per surrounding noise.



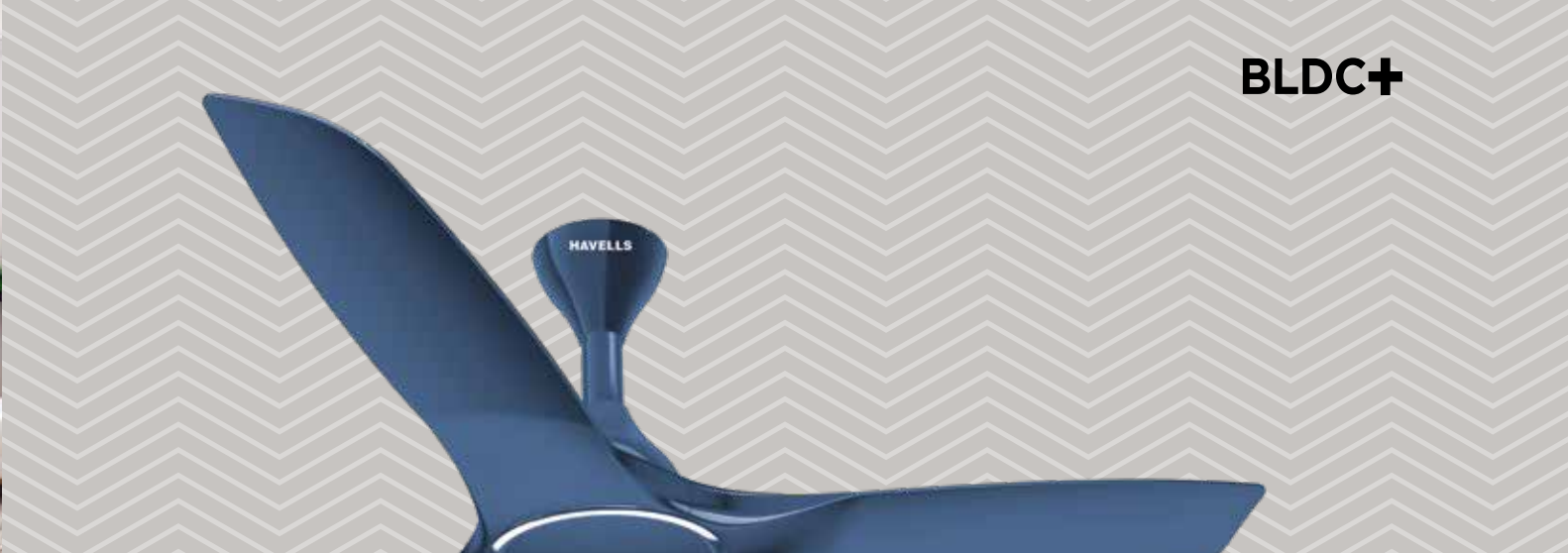

STEALTH AIR BLDC



Premium PU finish
ABS Blades



RF remote control for
all direction sensing



Silent 52 dB
Noise Level



Free
Installation



Reverse
Rotation



- Aerodynamic Blades for Superior Air Delivery
- Breeze, Sleep and Mop modes. Timer setting upto 8 hours
- Reverse Rotation for circulating warm air during winter
- Complete Silent Operation with 52 dB* only noise level

STAR RATING	SWEEP	POWER INPUT	SPEED	AIR DELIVERY
	1200 mm	37 W	280 r/min	240 m ³ /min
	900 mm	26 W	400 r/min	145 m ³ /min
	1200 mm	40 W	280 r/min	245 m ³ /min



Indigo Blue



Pearl White



Metallic Black



Mist



Champagne



Slate

NOTE : Pearl White and Metallic Black finishes without remote are also available. 1200 mm 4 star variant is without remote. 900 mm size is available in Pearl White Finish only with and without remote. *May vary as per surrounding noise.



STEALTH SLIM



Aerodynamic ABS blades



RF remote control for all direction sensing



Reverse Rotation



Silent 52 dB Noise Level

- Aerodynamic ABS blades for high air delivery
- Breeze, Sleep and Mop modes. Timer setting upto 8 hours
- Completely Silent Operation with 52 dB* only noise level
- Reverse Rotation for circulating warm air during winter

STAR RATING	SWEEP	POWER INPUT	SPEED	AIR DELIVERY
	1200 mm	37 W	290 r/min	240 m ³ /min

*May vary as per surrounding noise.



Stone Grey



Graphite

Oatmeal

Satin White



BLDC+

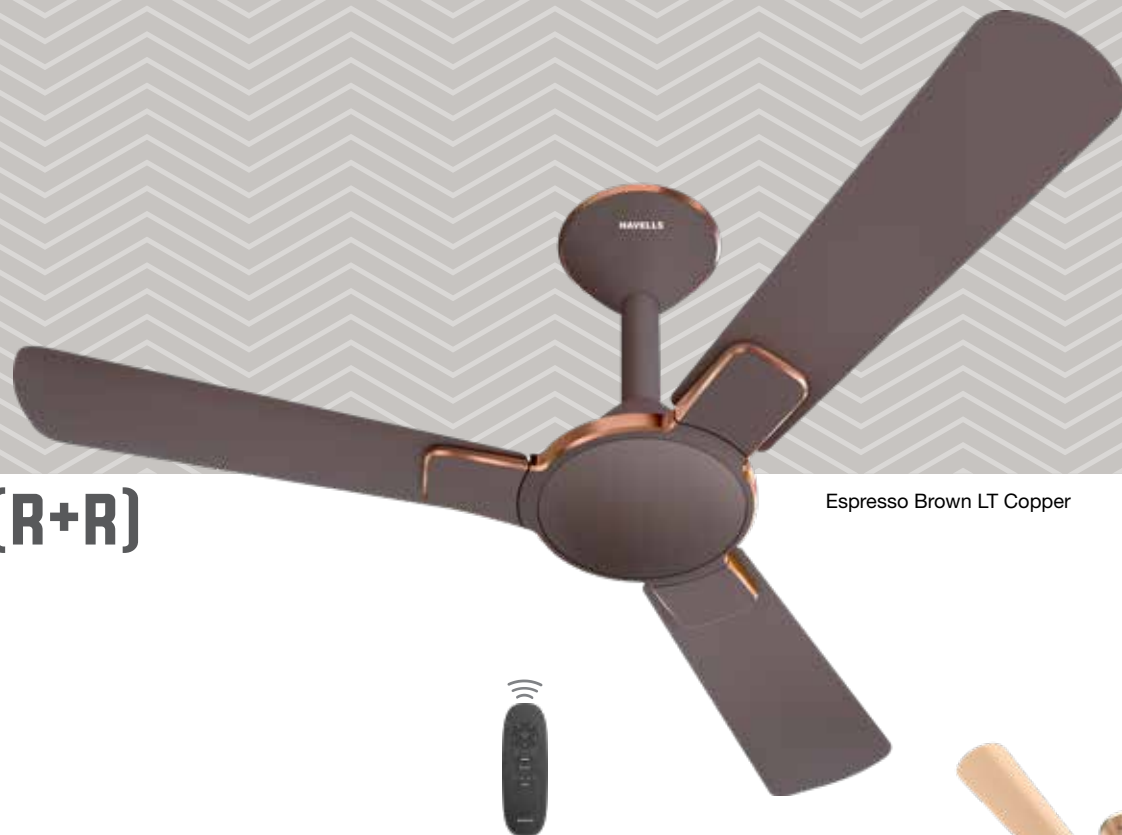

Espresso Brown LT Copper

ENTICER PRIME BLDC (R+R) DUAL CONTROL



RF remote control for all direction sensing

Reverse Rotation



- Dual Control: Operates both on Remote & Regulator
- Reverse Rotation for circulating warm air during winter
- Wide blades for high air delivery
- Breeze, Sleep and Mop modes. Timer setting upto 8 hours



Champagne



Pearl White Chrome



Bronze Copper Cola Chrome



STAR RATING	SWEEP	POWER INPUT	SPEED	AIR DELIVERY
	1400 mm	35 W	300 r/min	250 m ³ /min
	1200 mm	35 W	370 r/min	235 m ³ /min

NOTE : 1400 mm size is available in Pearl White Chrome Finish only.



BLDC+



NEON

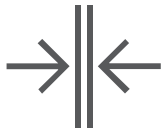

Sleek & Minimalistic Design



RF remote control for all direction sensing



Reverse Rotation



380 Revolutions Per Minute Hi Speed Mode

- Slimmest Fan from the House of Havells
- Sleek & Minimalistic Design to enhance room decor
- Reverse Rotation for spreading warm air during winter
- Breeze, Sleep, Boost and Mop modes. Timer setting upto 8 hours

STAR RATING	SWEEP	POWER INPUT	SPEED	AIR DELIVERY
	1200 mm	30 W	350 r/min	220 m ³ /min



Matt Black



Matt White



ELIO PRIME WOOD

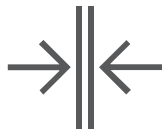

Sleek & Minimalistic Design



RF remote control for all direction sensing



Telescopic Canopy



Reverse Rotation



380 Revolutions Per Minute Hi Speed Mode

- Telescopic canopy for adjusting to various ceiling heights
- Breeze, Sleep, Boost and Mop modes. Timer setting upto 8 hours
- Peak Performance with speed 380 Revolutions Per Minute and air delivery 235 m³/min on Boost Mode
- Reverse Rotation for circulating warm air during winter

STAR RATING	SWEEP	POWER INPUT	SPEED	AIR DELIVERY
	1200 mm	28 W	350 r/min	225 m ³ /min



Walnut Matt Black



Pinewood Matt Black



ELIO PLUS R & R DUAL CONTROL

Espresso Brown

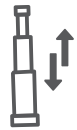

Telescopic Height



Reverse Rotation

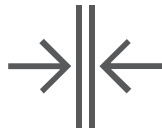

Sleek & Minimalistic Design



380 Revolutions Per Minute Hi Speed Mode



RF remote control for all direction sensing



Dusk



Pearl White

- Dual Control: Operates both on Remote & Regulator
- Telescopic canopy for adjusting to various ceiling heights
- Peak Performance with speed 380 Revolutions Per Minute and air delivery 235 m³/min on Boost Mode
- Metallic Dust resistant finish
- Reverse Rotation for circulating warm air during winter
- Breeze, Sleep, Boost and Mop modes. Timer setting upto 8 hours

STAR RATING	SWEEP	POWER INPUT	SPEED	AIR DELIVERY
	1200 mm	28 W	350 r/min	225 m ³ /min





BLDC+



Smoke Brown

EPIC VOICE

BLDC 3.0



Direct Voice Command



No Internet Required



RF remote control for all direction sensing



Sleek & Minimalistic Design



Reverse rotation



380 Revolutions Per Minute Hi Speed Mode

- Direct Voice Controlled Fan with Innovative AI Technology
- Talk To Your Fan Directly. No Internet / Wifi / Smart Phone or Bluetooth Required
- Hindi & English voice recognition with 29 commands
- Peak Performance with speed 380 Revolutions Per Minute and air delivery 235 m³/min on Boost Mode
- Most Efficient Fan with Lowest power consumption of 30 W, Upto 50%* Energy Saving & Best Service Value of 7.5
- Reverse Rotation for circulating warm air during winter
- Breeze, Sleep, Mop and Boost modes. Timer setting upto 8 hours

STAR RATING	SWEEP	POWER INPUT	SPEED	AIR DELIVERY
	1200 mm	30 W	350 r/min	225 m ³ /min

NOTE : Energy saving as compared with 1 star rated fans.



Stone Grey



Elegant White



Scan to Know Voice Cammands



Denim Blue

EPIC SIGNIA SMART



Reverse Rotation



Sleek & Minimalistic Design



LED Display for Speed & Modes



Agentic AI Voice Logo



RF remote control for all direction sensing



Mobile Smart



380 Revolutions Per Minute Hi Speed Mode

- Smart Control through mobile via Voice Command & Havells One App
- Unique LED display to indicate speed & mode
- Peak Performance with speed 380 Revolutions Per Minute and air delivery 235 m³/min on Boost Mode
- Most Efficient Fan with Lowest power consumption of 30 W, Upto 50%* Energy Saving & Best Service Value of 7.5
- Reverse Rotation for circulating warm air during winter
- Breeze, Sleep, Mop and Boost modes. Timer setting upto 8 hours

STAR RATING	SWEEP	POWER INPUT	SPEED	AIR DELIVERY
	1200 mm	30 W	350 r/min	225 m ³ /min

NOTE : Energy saving as compared with 1 star rated fans.



Smoke Brown



Cocoa Brown



Stone Grey



Elegant White



Smoke Brown

EPIC PLUS R & R DUAL CONTROL



Sleek & Minimalistic Design



RF remote control for all direction sensing



380 Revolutions Per Minute Hi Speed Mode



Reverse Rotation



- Dual Control: Operates both on Remote & Regulator
- Peak Performance with speed 380 Revolutions Per Minute and air delivery 235 m³/min on Boost Mode
- Most Efficient Fan with Lowest power consumption of 30 W, Upto 50%* Energy Saving & Best Service Value of 7.5
- Reverse Rotation for circulating warm air during winter
- Breeze, Sleep, Mop and Boost modes. Timer setting upto 8 hours



Cocoa Brown



Elegant White

STAR RATING	SWEEP	POWER INPUT	SPEED	AIR DELIVERY
	1200 mm	30 W	350 r/min	225 m ³ /min



NOTE : Energy saving as compared with 1 star rated fans.



EPIC LED



Reverse Rotation



LED Display for Speed & Modes



380 Revolutions Per Minute Hi Speed Mode



RF remote control for all direction sensing



Sleek & Minimalistic Design

- Unique LED display to indicate speed & mode
- Peak Performance with speed 380 Revolutions Per Minute and air delivery 235 m³/min on Boost Mode
- Most Efficient Fan with Lowest power consumption of 30 W, Upto 50%* Energy Saving & Best Service Value of 7.5
- Reverse Rotation for circulating warm air during winter
- Breeze, Sleep, Mop and Boost modes. Timer setting upto 8 hours

STAR RATING	SWEEP	POWER INPUT	SPEED	AIR DELIVERY
	1200 mm	30 W	350 r/min	225 m ³ /min

NOTE : Energy saving as compared with 1 star rated fans.

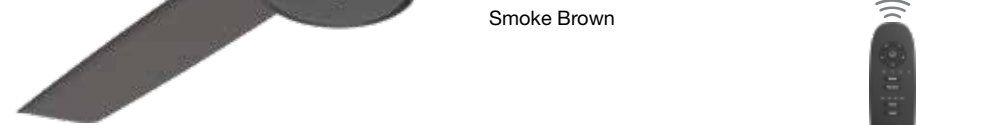

Smoke Brown



Denim Blue



Cocoa Brown



Stone Grey



Elegant White



EPIC PRO WOOD

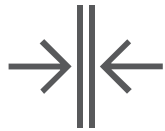

Sleek & Minimalistic Design



RF remote control for all direction sensing



380 Revolutions Per Minute Hi Speed Mode



Reverse Rotation



- Peak Performance with speed 380 Revolutions Per Minute and air delivery 235 m³/min on Boost Mode
- Most Efficient Fan with Lowest power consumption of 30 W, Upto 50%* Energy Saving & Best Service Value of 7.5
- Reverse Rotation for circulating warm air during winter
- Breeze, Sleep, Mop and Boost modes. Timer setting upto 8 hours

STAR RATING	SWEEP	POWER INPUT	SPEED	AIR DELIVERY
	1200 mm	30 W	350 r/min	225 m ³ /min

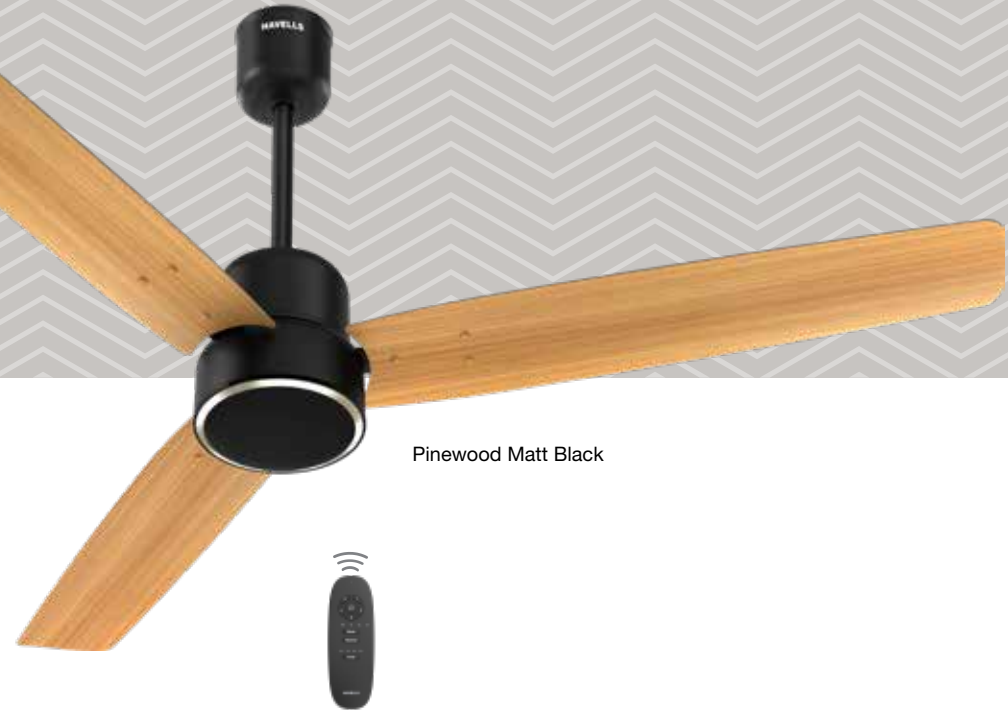

Pinewood Matt Black



Walnut Matt Black

NOTE : Energy saving as compared with 1 star rated fans.



EPIC BLDC

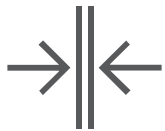

Sleek & Minimalistic Design



RF remote control for all direction sensing



380 Revolutions Per Minute Hi Speed Mode



Reverse Rotation

Denim Blue



- Peak Performance with speed 380 Revolutions Per Minute and air delivery 235 m³/min on Boost Mode
- Most Efficient Fan with Lowest power consumption of 30 W, Upto 50%* Energy Saving & Best Service Value of 7.5
- Reverse Rotation for circulating warm air during winter
- Breeze, Sleep, Mop and Boost modes. Timer setting upto 8 hours

STAR RATING	SWEEP	POWER INPUT	SPEED	AIR DELIVERY
	1400 mm	35 W	300 r/min	250 m ³ /min
	1200 mm	30 W	350 r/min	225 m ³ /min
	900 mm	28 W	430 r/min	160 m ³ /min
	600 mm	28 W	730 r/min	112 m ³ /min



Elegant White



Stone Grey



Cocoa Brown



Smoke Brown

NOTE : Energy saving as compared with 1 star rated fans.



EFFICIENCIA NEO PLUS BLDC



Lowest Power Consumption 26 W



RF remote control for all direction sensing



Reverse Rotation

- Ribbed Blades for High Strength
- Reverse Rotation for circulating warm air during winter
- Breeze, Sleep, Boost and Mop modes. Timer setting upto 8 hours





Elegant White



Cocoa Brown



STAR RATING	SWEEP	POWER INPUT	SPEED	AIR DELIVERY
	1400 mm	33 W	300 r/min	245 m ³ /min
	1200 mm	26 W	350 r/min	220 m ³ /min
	900 mm	28 W	430 r/min	160 m ³ /min

NOTE : Without Remote variants are also available





LOOK UP TO

SPECIAL
FINISH
FANS





OCTET ES UNDERLIGHT



Walnut Black Nickel



Underlight with Color changing tech

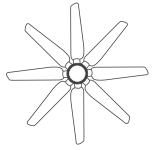

8 Wooden Finish blades



Free Installation



Low Noise



RF remote control for all direction sensing



- Mood Changing Underlight with Dimmable & Tunable Technique
- High Air Delivery & Silent Operation
- Breeze & Sleep mode. Timer setting upto 8 hours.

STAR RATING	SWEEP	POWER INPUT	SPEED	AIR DELIVERY
	1320 mm	57 W	280 r/min	260 m ³ /min



Wenge Brushed Nickel



Antique Brass

ORION ES



- Exotic Rich looks with Lacquered Anti-rust Surface
- Wider Blades for Better Air Circulation
- Electroplated finish to complement room decor



Antique Copper



Brushed Nickel

STAR RATING	SWEEP	POWER INPUT	SPEED	AIR DELIVERY
	1200 mm	50 W	370 r/min	225 m ³ /min



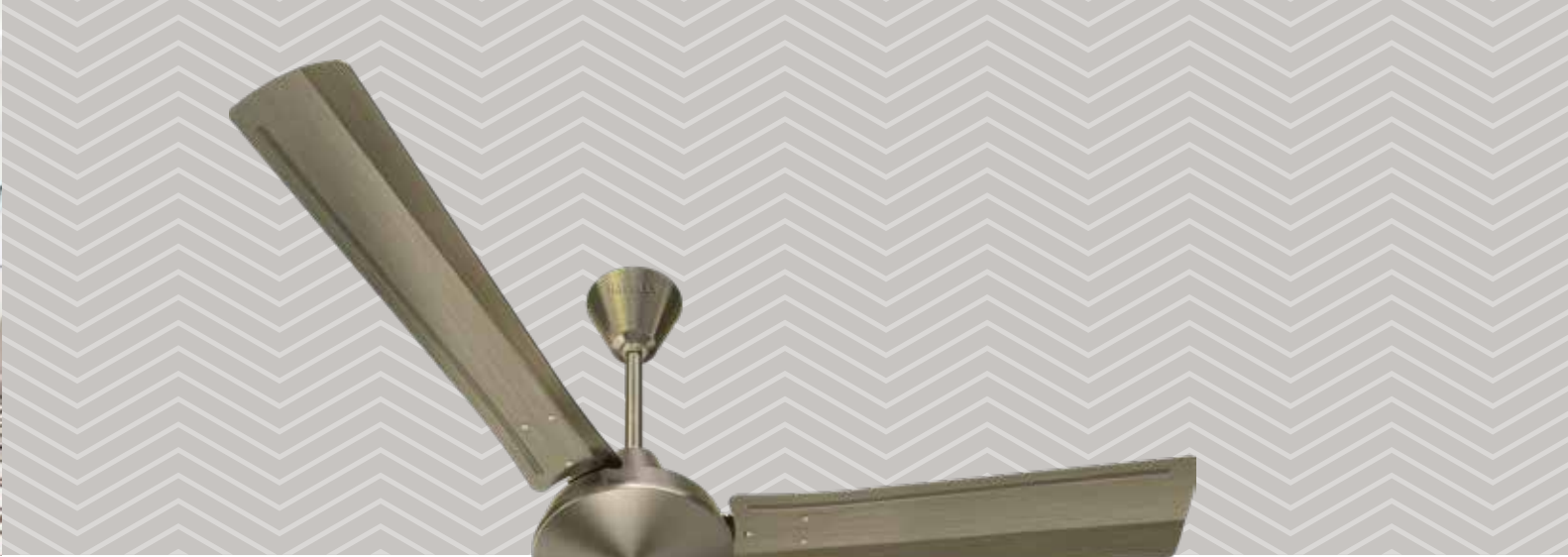



EP TRENDY ES



- Exotic Rich looks with Lacquered Anti-rust Surface
- Wider Blades for Better Air Circulation
- Electroplated finish to complement room decor

STAR RATING	SWEEP	POWER INPUT	SPEED	AIR DELIVERY
	1200 mm	50 W	370 r/min	225 m ³ /min
	900 mm	39 W	420 r/min	140 m ³ /min
	600 mm	57 W	850 r/min	112 m ³ /min



Antique Brass



Brushed Nickel



Antique Copper





LOOK UP TO
DECORATIVE
CEILING
FANS



VICTORIS



Low Noise

- Premium aesthetics with novel decorative trims
- Fluidic motor and blade design for smooth and efficient performance
- Dust-resistance ensures low maintenance
- High air-delivery for superior room comfort

STAR RATING	SWEEP	POWER INPUT	SPEED	AIR DELIVERY
	1200 mm	48 W	370 r/min	220 m ³ /min



Metallic Bronze

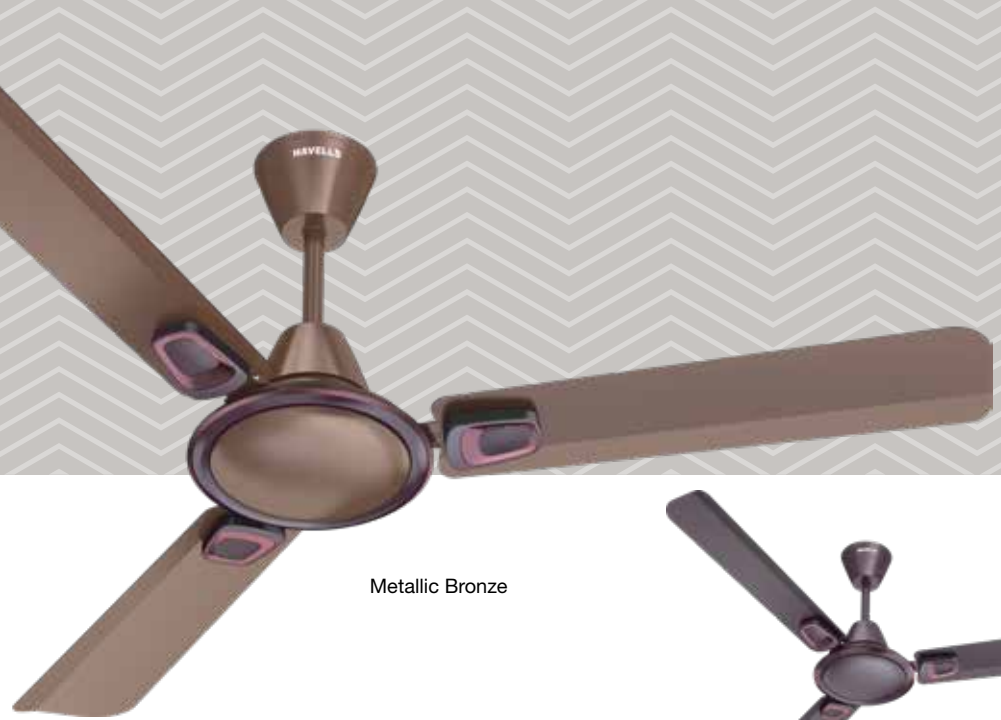

Dusk



Pearl White



Ocean Blue

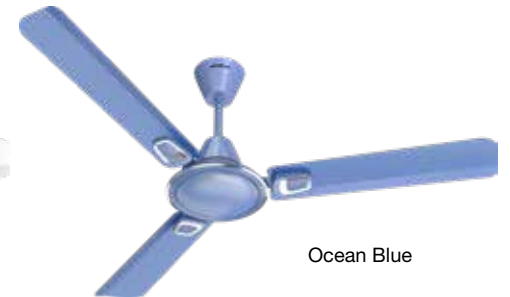

Mist

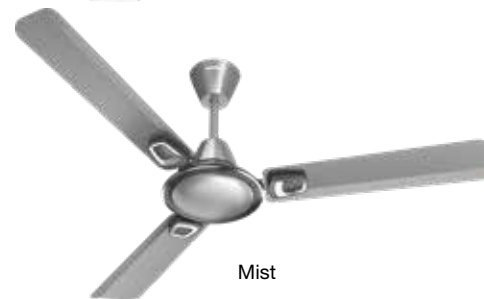

Quartz







ENTICER ART HS

LIMITED EDITION



- Unique IMD pattern complements room decor
- High-performance motor for superior air delivery
- Elegant and stylish trim for premium aesthetics
- Compatible with home automation systems
- Wider blade tip with premium metallic paint finish

STAR RATING	SWEEP	POWER INPUT	SPEED	AIR DELIVERY
	1400 mm	54 W	290 r/min	250 m ³ /min
	1200 mm	50 W	390 r/min	225 m ³ /min
	900 mm	39 W	420 r/min	140 m ³ /min

Metallic Black

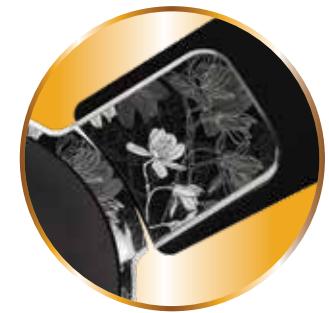

Pearl White





ENTICER ART HS

HERITAGE & COLLECTOR EDITION



- Unique IMD pattern trim complements room decor
- High-performance motor for superior air delivery
- Elegant and stylish trim for a premium aesthetics
- Compatible with home automation systems
- Wider blade tip with premium metallic paint finish

Espresso Brown Copper Heritage Edition

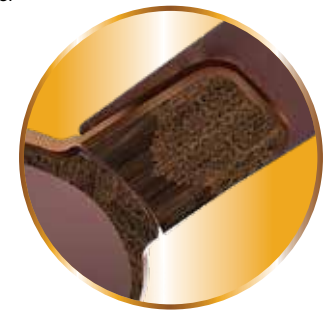

STAR RATING	SWEEP	POWER INPUT	SPEED	AIR DELIVERY
	1200 mm	50 W	390 r/min	225 m ³ /min



Rose Gold Collector Edition



ENTICER HS WOOD



- Unique Wood pattern complements room decor
- High-performance motor for superior air delivery
- Elegant and stylish trim for premium aesthetics
- Compatible with home automation systems
- Wider blade tip with premium metallic paint finish

STAR RATING	SWEEP	POWER INPUT	SPEED	AIR DELIVERY
	1200 mm	50 W	390 r/min	225 m ³ /min



Oakwood



Rosewood



Walnut

ENTICER ART HS VINEER EDITION



- Unique Wood pattern complements room decor
- High-performance motor for superior air delivery
- Elegant and stylish trim for premium aesthetics
- Compatible with home automation systems
- Wider blade tip with premium metallic paint finish

STAR RATING	SWEEP	POWER INPUT	SPEED	AIR DELIVERY
	1200 mm	50 W	390 r/min	225 m ³ /min



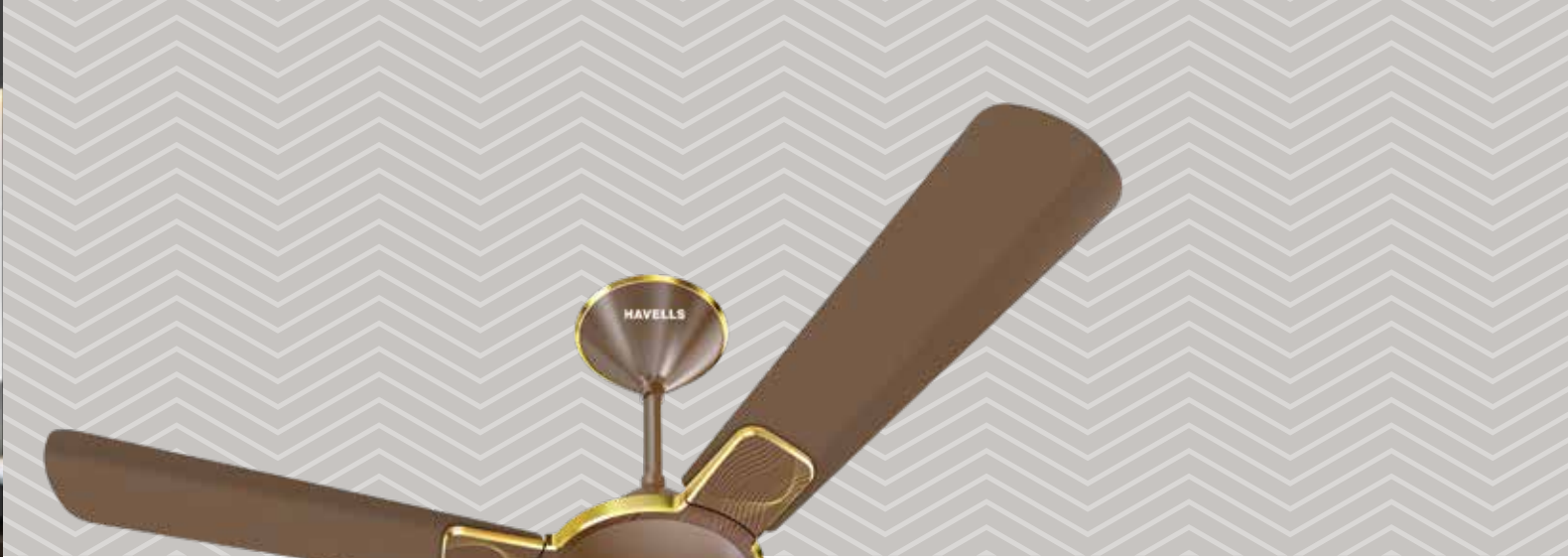

ENTICER ART HS

NATURE SERIES – STONE / FAUNA & WAVE



- Nature inspired unique Fauna, Stone & Wave Pattern enhances room decor
- Rich looks with modern styling
- Aerodynamically designed blade tip with Hi Speed motor
- Compatible with home automation systems

Wave Pearl Brown



Fauna Champagne



Stone Pearl White

STAR RATING	SWEEP	POWER INPUT	SPEED	AIR DELIVERY
	1200 mm	50 W	390 r/min	225 m ³ /min



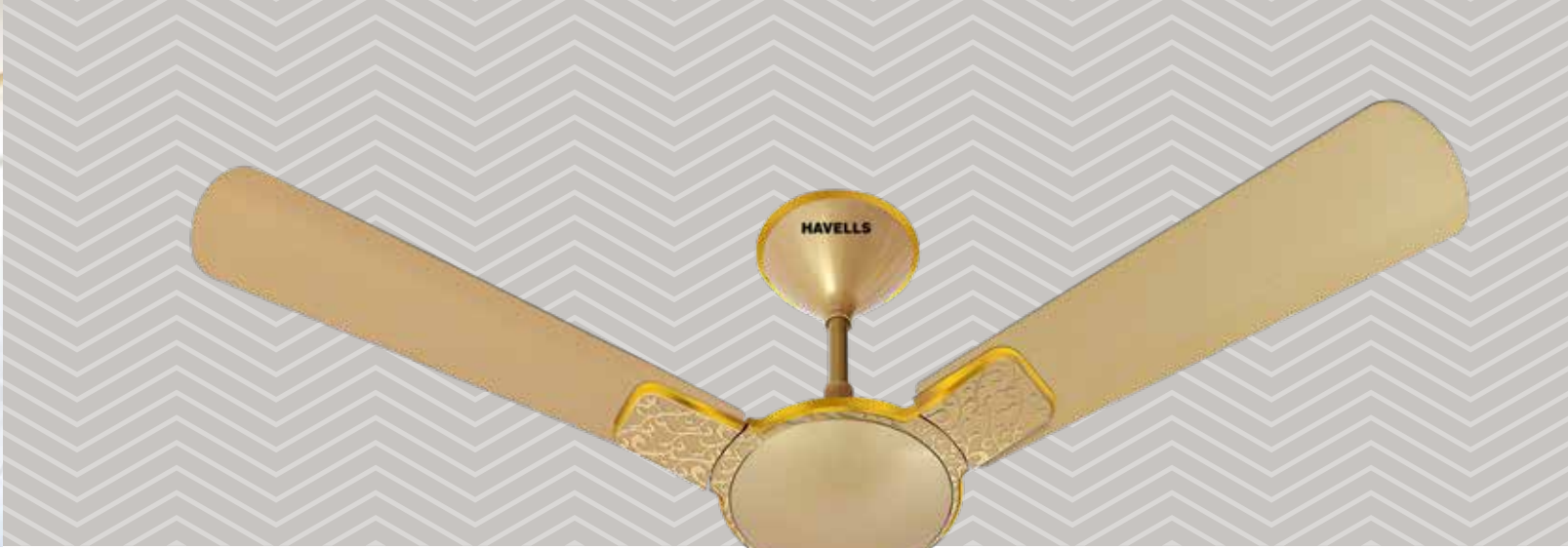

ENTICER ART HS HUES EDITION



GOLD



- Unique IMD HUES GOLD Pattern complements room decor
- Rich looks with modern styling
- Aerodynamically designed blade tip for high air delivery
- Compatible with home automation systems

STAR RATING	SWEEP	POWER INPUT	SPEED	AIR DELIVERY
	1200 mm	50 W	390 r/min	225 m ³ /min





ENTICER ART HS

NATURE SERIES – FLORA



- Nature inspired unique FLORA Pattern complements room decor
- Rich looks with modern styling
- Aerodynamically designed blade tip for high air delivery
- Compatible with home automation systems

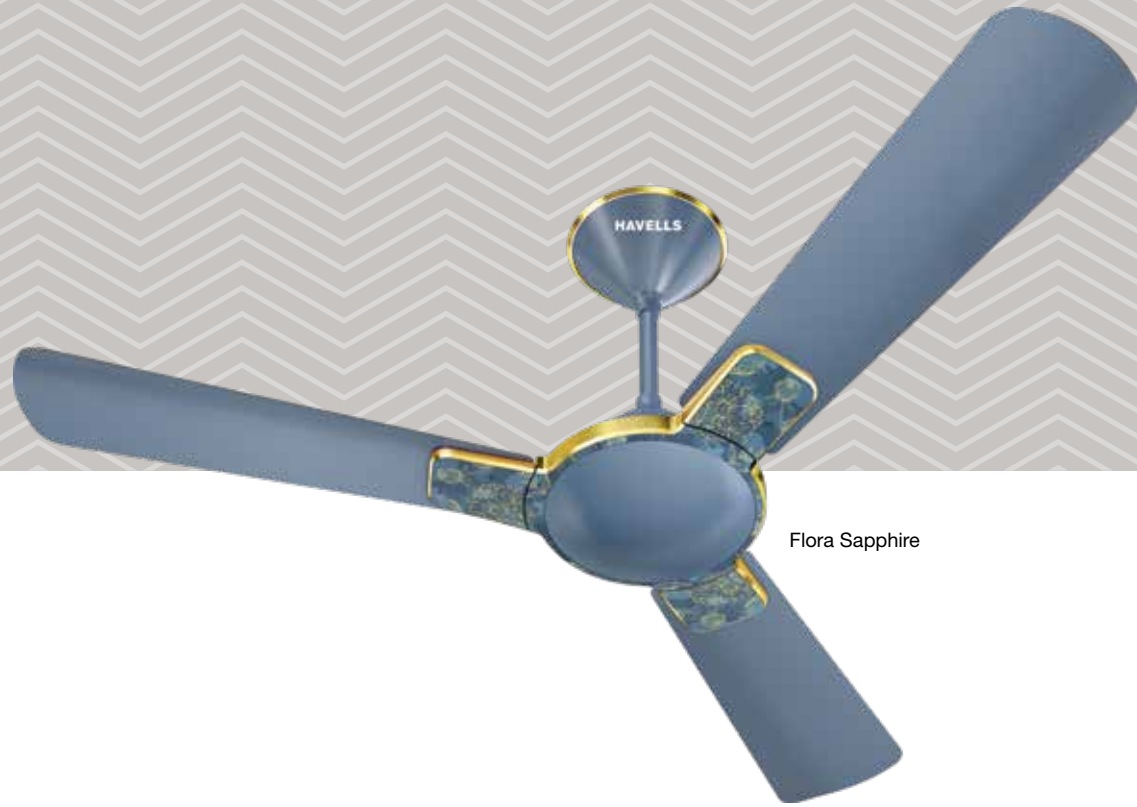

Flora Sapphire



Flora Beige



Flora Espresso Brown

STAR RATING	SWEEP	POWER INPUT	SPEED	AIR DELIVERY
	1200 mm	50 W	390 r/min	225 m ³ /min





ENTICER HS

Bronze Cola Chrome



- High-performance motor for superior air delivery
- Elegant and stylish trim for premium aesthetics
- Aerodynamically designed blade tip for high air delivery
- Compatible with home automation systems

STAR RATING	SWEEP	POWER INPUT	SPEED	AIR DELIVERY
	1400 mm	54 W	290 r/min	250 m ³ /min
	1200 mm	50 W	390 r/min	225 m ³ /min
	900 mm	39 W	420 r/min	140 m ³ /min
	600 mm	57 W	850 r/min	112 m ³ /min

Note: Dust resistant coating is applicable on glossy finish only.





EXTER NEO



Low Noise



Dual tone Blade Trim



Rust Proof

- High-speed performance for superior air delivery
- Energy-efficient motor
- Robust, large-diameter motor for enhanced durability and performance
- Easy-to-clean design for effortless maintenance
- Premium aesthetics enhances room decor

STAR RATING	SWEEP	POWER INPUT	SPEED	AIR DELIVERY
	1200 mm	50 W	370 r/min	225 m ³ /min



Grey Mauve

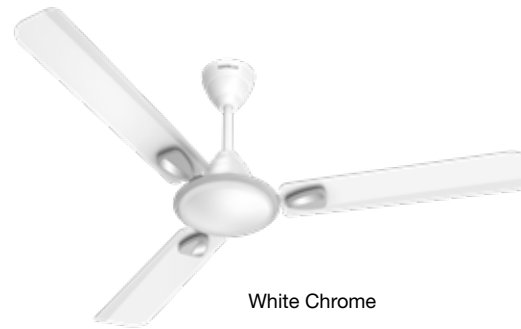

White Chrome



Smoke Cola

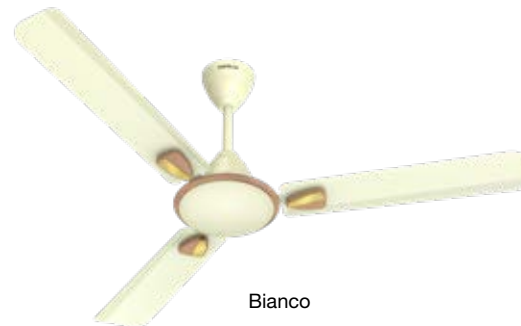

Bianco



Midnight Black



LEGANZA HS

4 BLADES



Unique 4 blade design

- High-performance motor for superior air delivery
- Elegant and stylish trim for premium aesthetics
- Compatible with home automation systems

STAR RATING	SWEEP	POWER INPUT	SPEED	AIR DELIVERY
	1200 mm	50 W	370 r/min	225 m ³ /min



Mist Honey



Bronze Gold



Pearl White Silver



FESTIVA HS METALLIC



- High-performance motor for superior air delivery
- Elegant and stylish trim for premium aesthetics
- Aerodynamically designed blade tip for high air delivery
- Compatible with home automation systems

Ocean Blue Silver



Champagne



Espresso Brown



Slate



Pearl White Silver



Pearl Copper



Metallic Cream



Gold Mist

STAR RATING	SWEEP	POWER INPUT	SPEED	AIR DELIVERY
	1200 mm	50 W	370 r/min	225 m ³ /min



Note: Dust resistant coating is applicable on glossy finish only.



FUSION ES



Low Noise

- High-performance motor for superior air delivery
- Elegant and stylish trim for premium aesthetics
- Compatible with home automation systems
- High performance even at low voltage

Beige Brown



STAR RATING	SWEEP	POWER INPUT	SPEED	AIR DELIVERY
	1200 mm	50 W	370 r/min	225 m ³ /min





QUICK AIR NEO

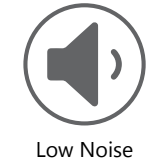

- High-performance motor for superior air delivery
- Elegant and stylish trim for premium aesthetics
- Compatible with home automation systems

STAR RATING	SWEEP	POWER INPUT	SPEED	AIR DELIVERY
	1400 mm	60 W	290 r/min	245 m ³ /min
	1200 mm	50 W	390 r/min	225 m ³ /min
	900 mm	42 W	420 r/min	140 m ³ /min
	600 mm	60 W	800 r/min	100 m ³ /min



Stone Grey

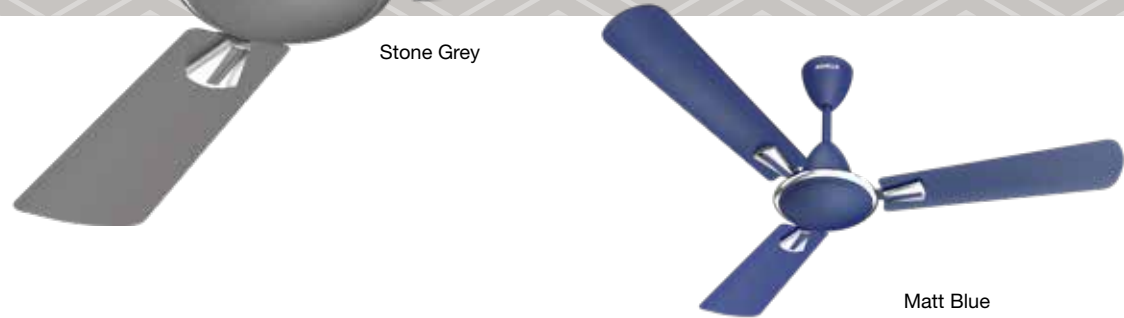

Matt Blue



Desert Gold

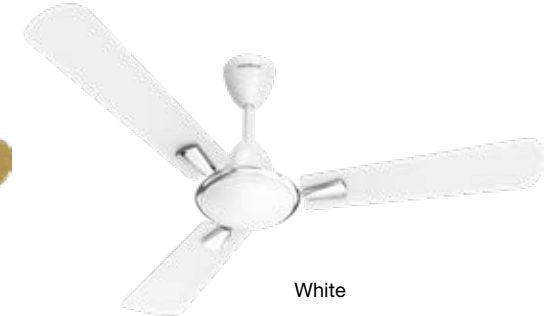

White



Bianco



Smoke Brown



ANDRIA NEO METALLIC



High Air Delivery

Low Noise

- Modern Slim design for elegant room interiors
- Lacquer metallic paint for better aesthetics
- Ribbed blades for high air delivery & air thrust
- High Performance even on low voltage

STAR RATING	SWEEP	POWER INPUT	SPEED	AIR DELIVERY
	1200 mm	50 W	370 r/min	225 m ³ /min



Metallic Quartz



Metallic Pearl White



Espresso Brown

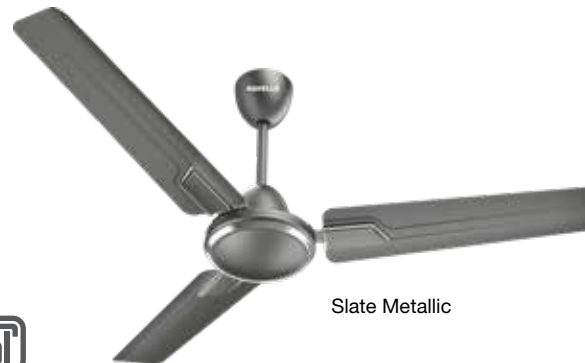

Slate Metallic



Indigo Blue



NICOLA HS

METALLIC



High Air Delivery



Low Noise

- High-performance motor for superior air delivery
- Elegant and stylish trim for premium aesthetics
- Compatible with home automation systems
- Dust-resistant coating

Gold Mist Copper



Pearl White Silver



Bronze Copper



Mist Silver



Dusk Copper

STAR RATING	SWEEP	POWER INPUT	SPEED	AIR DELIVERY
	1200 mm	50 W	370 r/min	225 m ³ /min









LOOK UP TO
**REGULAR
FANS**



SS 390 HS METALLIC



- High-performance motor for superior air delivery
- Elegant and stylish looks
- Compatible with home automation systems

STAR RATING	SWEEP	POWER INPUT	SPEED	AIR DELIVERY
	1400 mm	54 W	290 r/min	250 m ³ /min
	1200 mm	50 W	390 r/min	225 m ³ /min
	900 mm	39 W	420 r/min	140 m ³ /min
	600 mm	57 W	850 r/min	112 m ³ /min

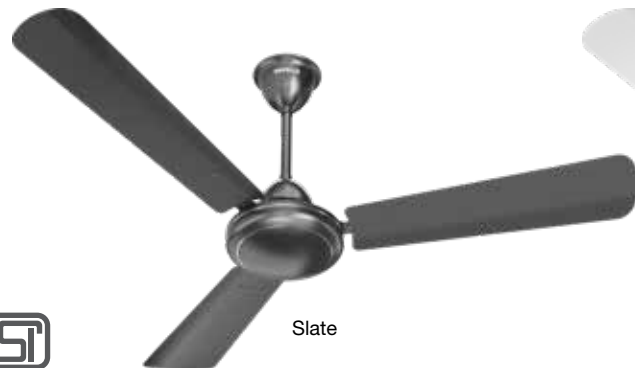

Slate



Pearl Ivory



Pearl White

Pearl Copper





SS 390 HS



**HIGH
SPEED**



Rust Proof

- High-performance motor for superior air delivery
- Elegant and stylish looks
- Compatible with home automation systems

STAR RATING	SWEEP	POWER INPUT	SPEED	AIR DELIVERY
	1400 mm	54 W	290 r/min	250 m ³ /min
	1200 mm	50 W	390 r/min	225 m ³ /min
	900 mm	39 W	420 r/min	140 m ³ /min
	600 mm	57 W	850 r/min	112 m ³ /min



Matt Black



Matt White

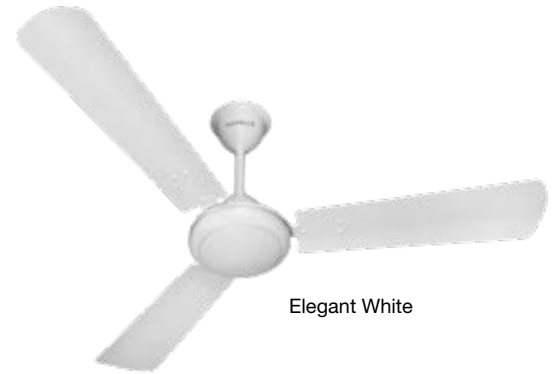

Elegant White



Brown

Bianco



ES 40

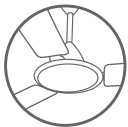

Wide Motor

Low Noise

Rust Proof

- Aerodynamic Blades for maximum air delivery
- High performance even at low voltage
- Compatible with home automation systems

Comparison of Cost Saving

Parameter & Criteria	Traditional Fan	1 Star	2 Star ES 40
Rated Wattage	75 W	50 W	40 W*
Energy consumption @ 16 hours/day	1.2 kWh (1.200 units)	0.8 kWh (800 units)	0.640 kWh (0.640 units)
Total Consumption of Electricity / Month	36.00 kWh (36.00 units)	24.00 kWh (24.00 units)	19.20 kWh (16.80 units)
Cost of Electricity / Month @ ₹ 7.00* per kWh (₹ 7.00 per unit)	₹ 252.00	₹ 168.00	₹ 134.40
Cost of Electricity in 12 Months	₹ 3024.00	₹ 2016.00	₹ 1612.80
Saving per year when compared to 1 star			₹ 403.20
Saving per year when compared to non star			₹ 1411.60

Calculation is based on average usage & cost of electricity for 1200 mm sweep
Wattage may vary upto 5% * Cost of electricity may vary from location to location.

White



Brown

STAR RATING	SWEEP	POWER INPUT	SPEED	AIR DELIVERY
	1200 mm	40 W	300 r/min	212 m ³ /min





SAMRAAT HS



Low Noise

Rust Proof

- High-performance motor for superior air delivery
- Elegant and stylish looks
- Compatible with home automation systems
- Glossy paint finish

STAR RATING	SWEEP	POWER INPUT	SPEED	AIR DELIVERY
	1400 mm	54 W	290 r/min	250 m ³ /min
	1200 mm	50 W	370 r/min	225 m ³ /min
	900 mm	39 W	420 r/min	140 m ³ /min
	600 mm	57 W	850 r/min	112 m ³ /min



Bianco



Elegant White

Brown



XPRESS HS



Low Noise

Rust Proof

- High-performance motor for superior air delivery
- Elegant and stylish for premium aesthetics
- Compatible with home automation systems
- Wider blade tip with superior Matt & Glossy paint finish

STAR RATING	SWEEP	POWER INPUT	SPEED	AIR DELIVERY
	1200 mm	48 W	370 r/min	220 m ³ /min



Brown



Smoke Brown



Elegant White



Denim Blue

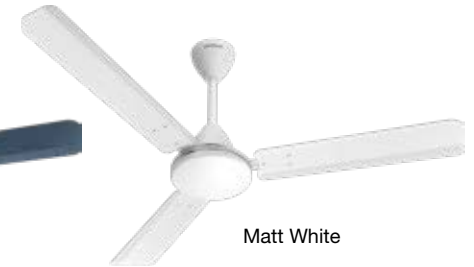

Matt White



Desert Gold



Cocoa Brown



Bianco



THRILL DECOR



Low Noise



Rust Proof

- Robust motor with large diameter
- Energy Efficient motor
- Exotic rich looks with dual tone variants
- Long lasting powder coated finish

STAR RATING	SWEEP	POWER INPUT	SPEED	AIR DELIVERY
	1400 mm	54 W	290 r/min	250 m ³ /min
	1200 mm	48 W	370 r/min	220 m ³ /min
	900 mm	39 W	420 r/min	140 m ³ /min
	600 mm	57 W	850 r/min	112 m ³ /min



Cocoa Brown



Matt Blue



Smoke Brown



Grey

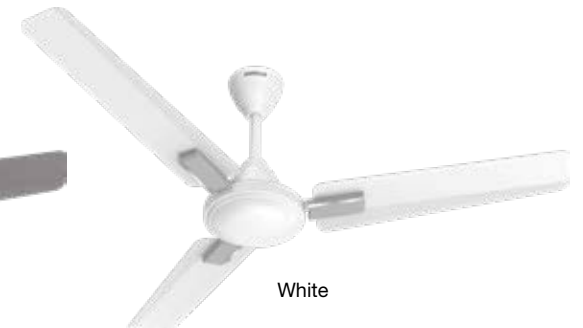

White



SAMRAAT NEO



Low Noise



Rust Proof

- Hi speed ceiling fan for better air delivery
- Sleek and minimalistic design enhances room decor
- Rust Proof body and blades

STAR RATING	SWEEP	POWER INPUT	SPEED	AIR DELIVERY
	1400 mm	54 W	290 r/min	250 m ³ /min
	1200 mm	48 W	370 r/min	220 m ³ /min
	900 mm	39 W	420 r/min	140 m ³ /min
	600 mm	60 W	850 r/min	112 m ³ /min



Smoke Brown



Elegant White



Stone Grey



Cocoa Brown



Denim Blue



Brown



Bianco



Desert Gold



Matt White



Blush Ivory



Matt Black

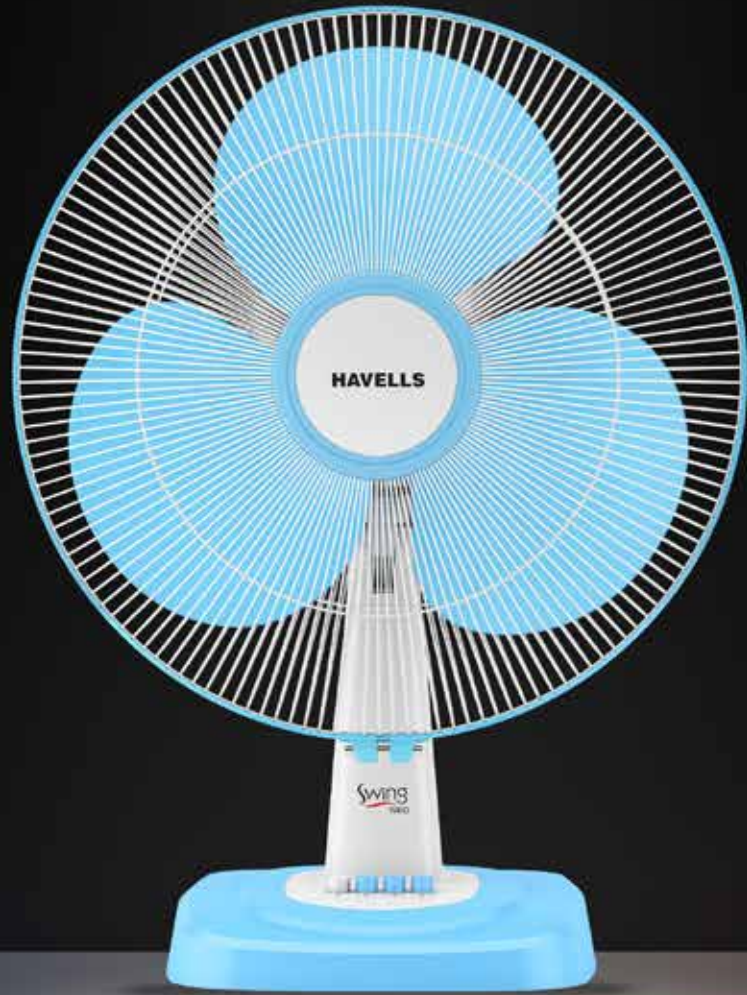

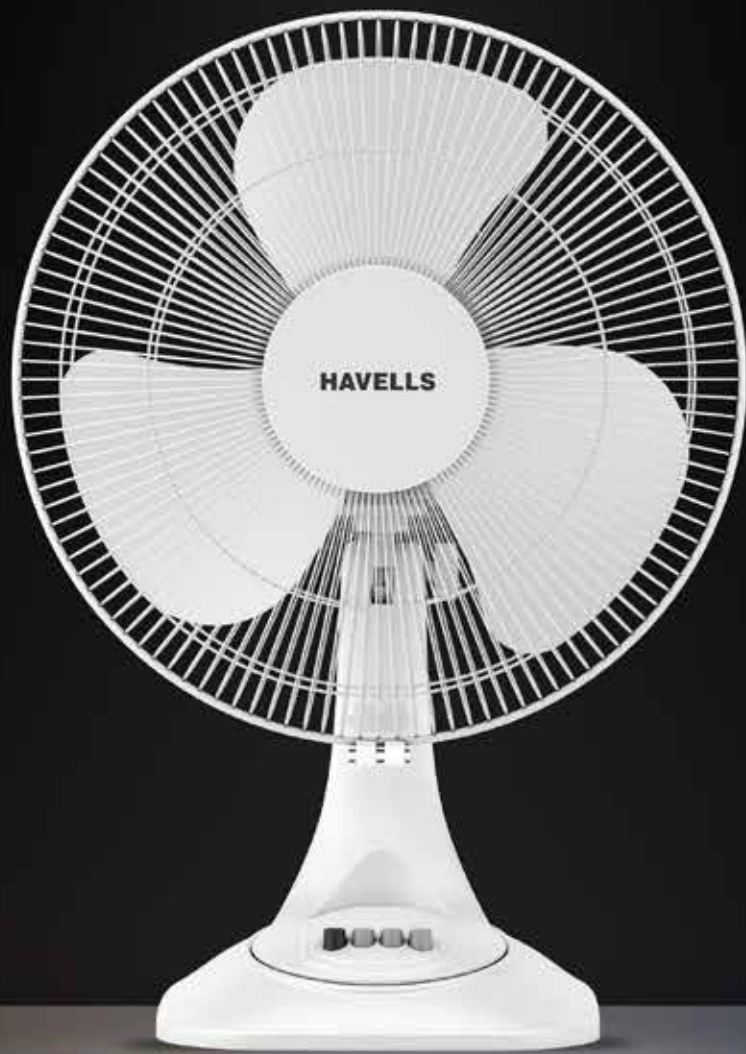
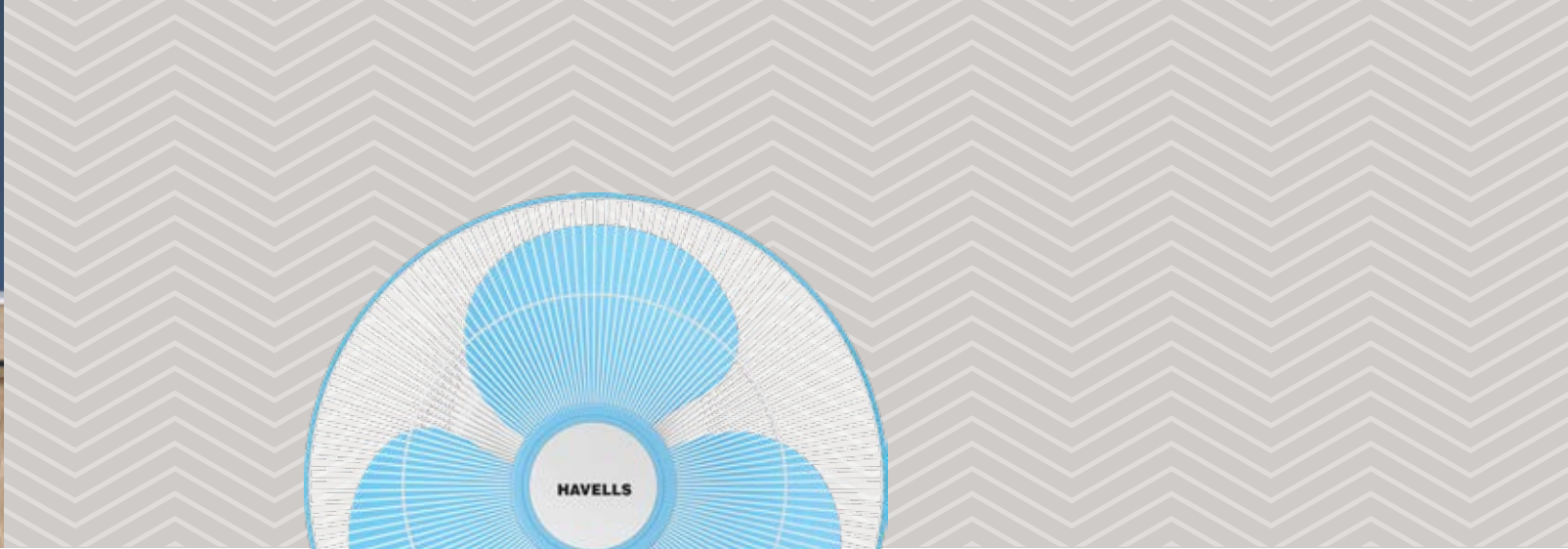

TABLE
FANS



SWING NEO



- WideVolt™ Motor ensures reliable operation across wide voltage range (150 V – 265 V)
- Fan Head Tilting Mechanism for Perfect Vertical Airflow Direction
- 3 Speed Regulation for convenience
- Jerk-Free & Smooth Oscillation

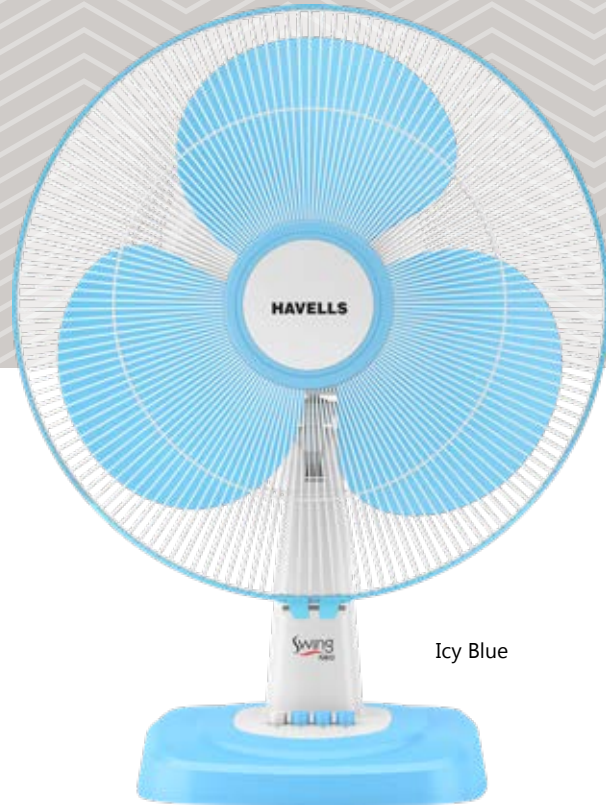

Icy Blue



White Grey

STAR RATING	SWEEP	POWER INPUT	SPEED	AIR DELIVERY
NA	400 mm	65 W	1350 r/min	75 m ³ /min





SWING PRO



Double Ball Bearing



- WideVolt™ Motor ensures reliable operation across wide voltage range (150 V – 265 V)
- New Aerodynamic Design Blade for High Air Thrust
- Fan Head Tilting Mechanism for Perfect Vertical Airflow Direction
- 3 Speed Regulation for convenience
- Jerk-Free & Smooth Oscillation

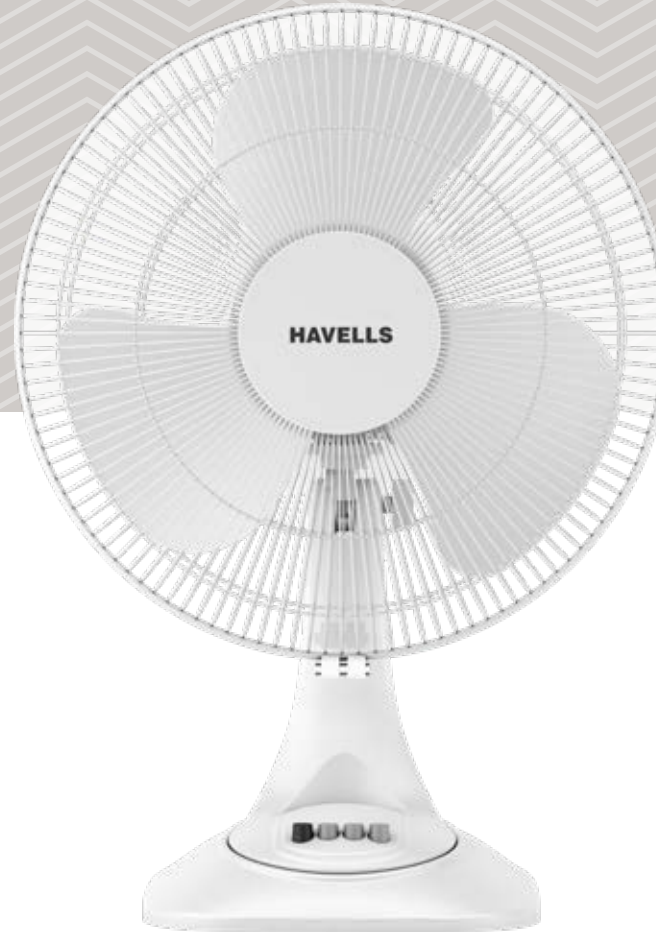

White

STAR RATING	SWEEP	POWER INPUT	SPEED	AIR DELIVERY
NA	400 mm	55 W	1350 r/min	82 m³/min



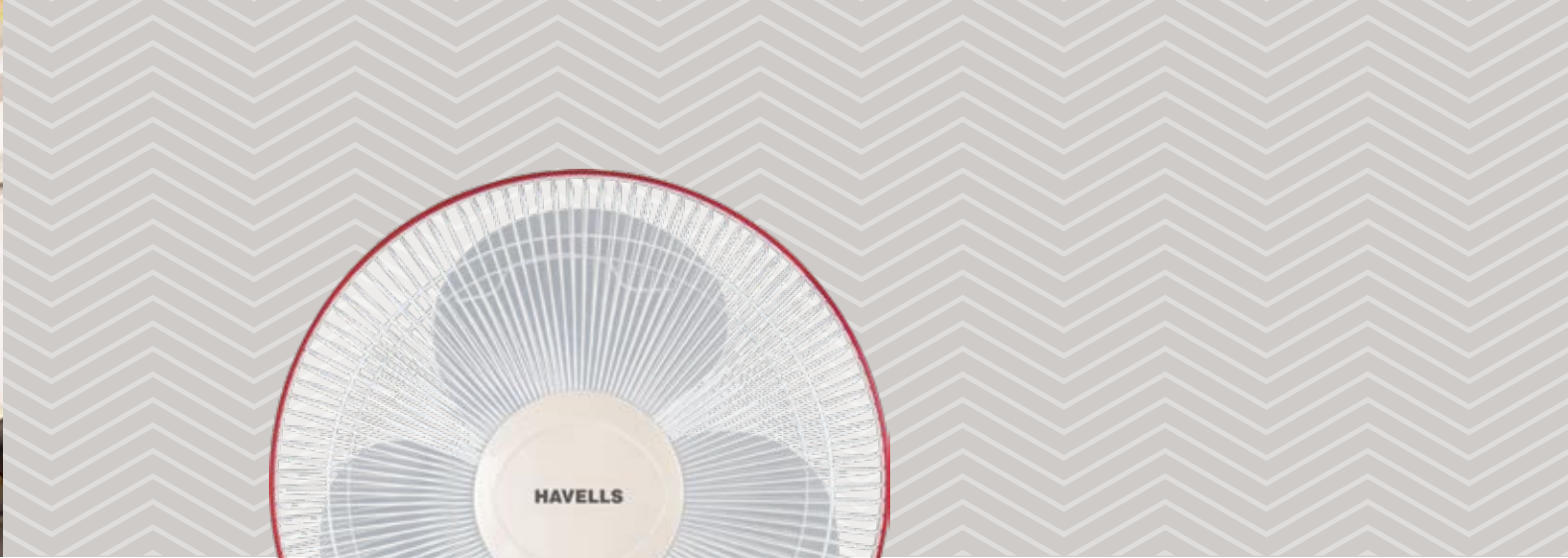

SWING LX



- WideVolt™ Motor ensures reliable operation across wide voltage range (150 V – 265 V)
- Fan Head Tilting Mechanism for Perfect Vertical Airflow Direction
- 3 Speed Regulation for convenience
- Jerk-Free & Smooth Oscillation

STAR RATING	SWEEP	POWER INPUT	SPEED	AIR DELIVERY
NA	400 mm	65 W	1350 r/min	75 m ³ /min

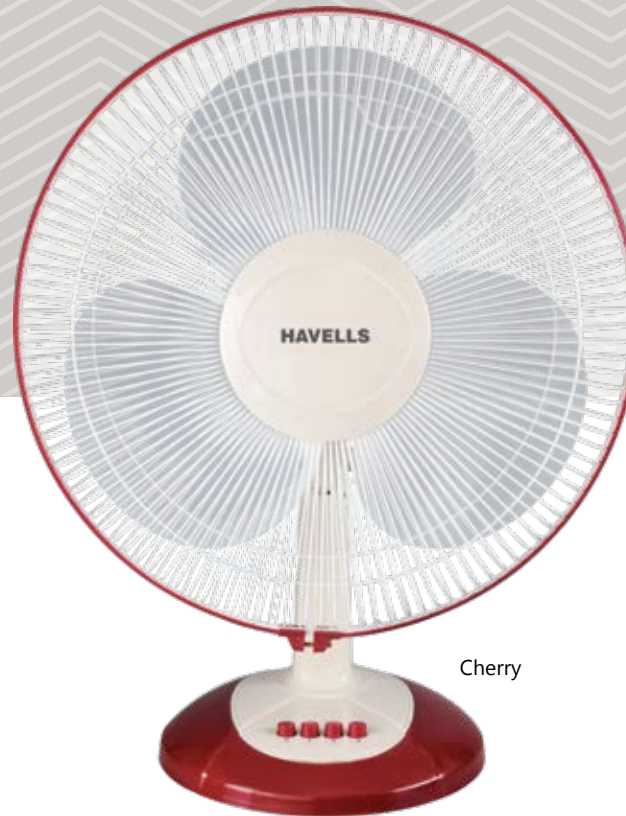

Cherry

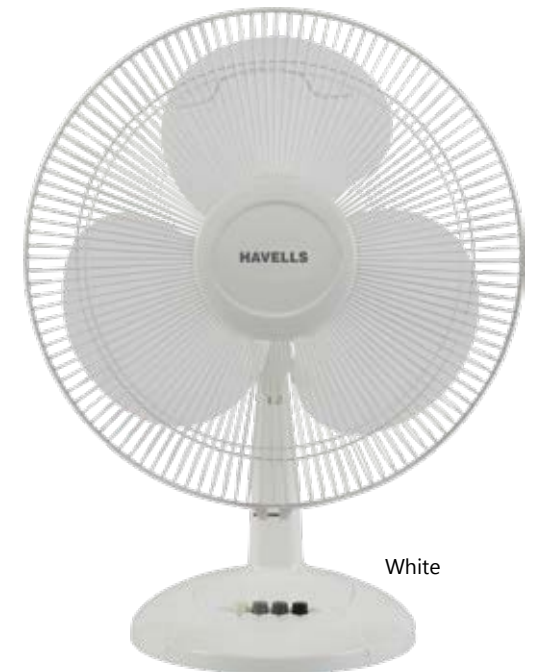

White





SWING PRO HS



Double Ball Bearing

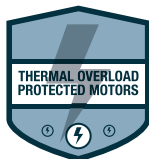

- WideVolt™ Motor ensures reliable operation across wide voltage range (150 V – 265 V)
- Fan Head Tilting Mechanism for Perfect Vertical Airflow Direction
- 3 Speed Regulation for convenience
- Jerk-Free & Smooth Oscillation

STAR RATING	SWEEP	POWER INPUT	SPEED	AIR DELIVERY
NA	400 mm	115 W	2150 r/min	105 m ³ /min

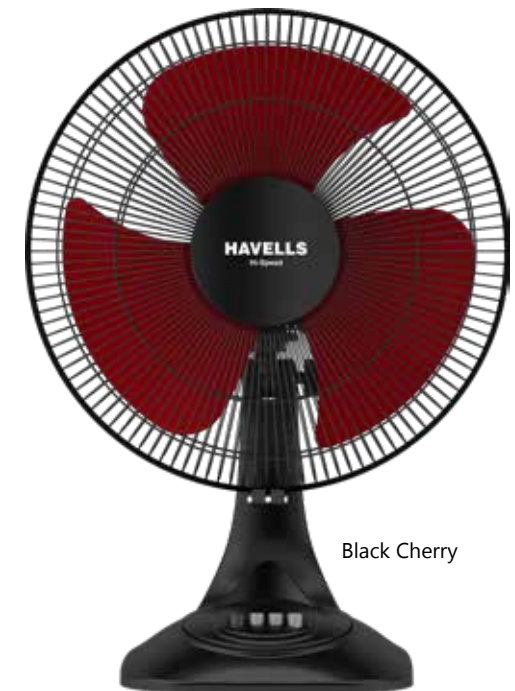
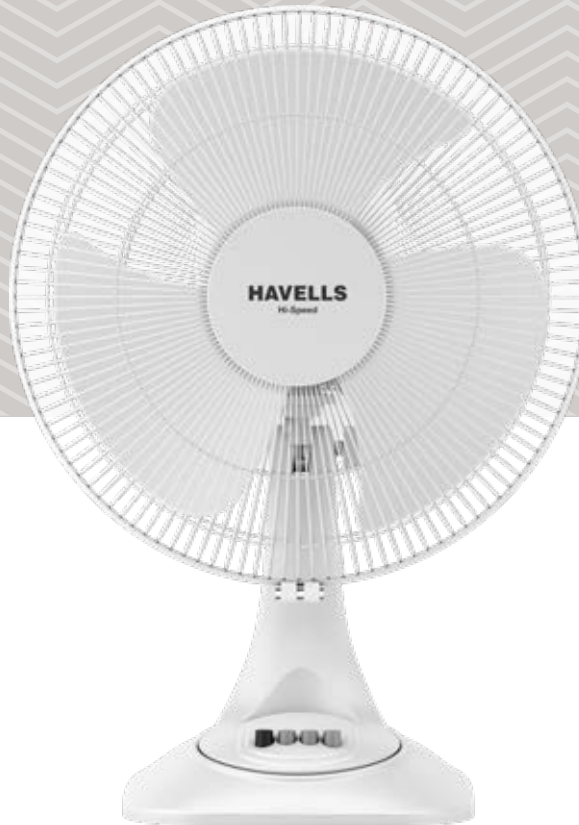

Black Cherry



SWING LX HS



Double Ball Bearing



- WideVolt™ Motor ensures reliable operation across wide voltage range (150 V – 265 V)
- Fan Head Tilting Mechanism for Perfect Vertical Airflow Direction
- 3 Speed Regulation for convenience
- Jerk-Free & Smooth Oscillation



Purple

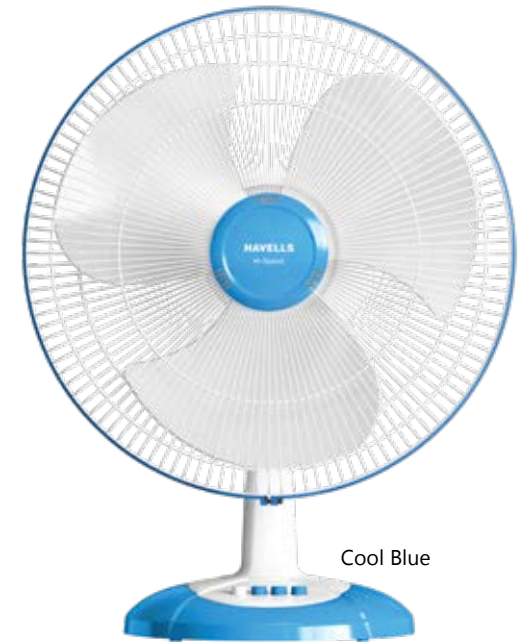

Cool Blue

STAR RATING	SWEEP	POWER INPUT	SPEED	AIR DELIVERY
NA	400 mm	125 W	2100 r/min	95 m ³ /min









PEDESTAL FANS



BLDC+



SPRINT BLDC



**BLDC INVERTER
TECHNOLOGY**



Low Power
Consumption



Low
Noise



Remote
Operation



- WideVolt™ Motor ensures reliable operation across wide voltage range (150 V – 265 V)
- Fan Head Tilting Mechanism for Perfect Vertical Airflow Direction
- Telescopic Arrangement for Full Height Adjustment from Collet
- Breeze & Sleep Mode, Timer upto 8 Hours
- Jerk-Free & Smooth Oscillation
- Stainless Steel Grade Pipe for High Strength & Rust Resistance

White Yellow

STAR RATING	SWEEP	POWER INPUT	SPEED	AIR DELIVERY
	400 mm	30 W	1350 r/min	72 m ³ /min





AINDRILA PREMIUM

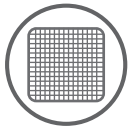

Square Guard



Remote Operation



- Standard, Natural, Breeze & Sleep Mode; Timer upto 8 hours
- Soft touch option for manual operation
- ABS body for high strength and gloss
- Stainless Steel Grade Pipe for High Strength & Rust Resistance
- Fan Head Tilting Mechanism for Perfect Vertical Airflow Direction
- Jerk free smooth oscillation



Brown Black

STAR RATING	SWEEP	POWER INPUT	SPEED	AIR DELIVERY
NA	400 mm	65 W	1350 r/min	75 m ³ /min





SPRINT-18 HS



Double Ball Bearing

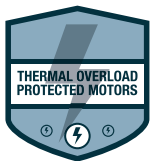

- Unique Blade Shape for premium aesthetics
- High air delivery
- Jerk Free Smooth Oscillation
- Fan Head Tilting Mechanism for Perfect Vertical Airflow Direction
- Stainless Steel Grade Pipe for High Strength & Rust Resistance

STAR RATING	SWEEP	POWER INPUT	SPEED	AIR DELIVERY
NA	450 mm	125 W	1750 r/min	100 m ³ /min



White



CELESTE



Tool-Free
— A S S E M B L Y —



- Uni-Pole Design with Soft Dial Switch ensures Elegant and user-friendly control
- Tactile Control Dial for Convenient speed regulation and ON/OFF functionality
- Wide Oscillation spreads airflow across a larger area
- Adjustable Height upto Three levels – 1270 mm, 952 mm, and 650 mm
- Tool-Free Assembly for Quick and easy setup for 2 in 1 Usage
- Stainless Steel Grade Pipe for High Strength & Rust Resistance

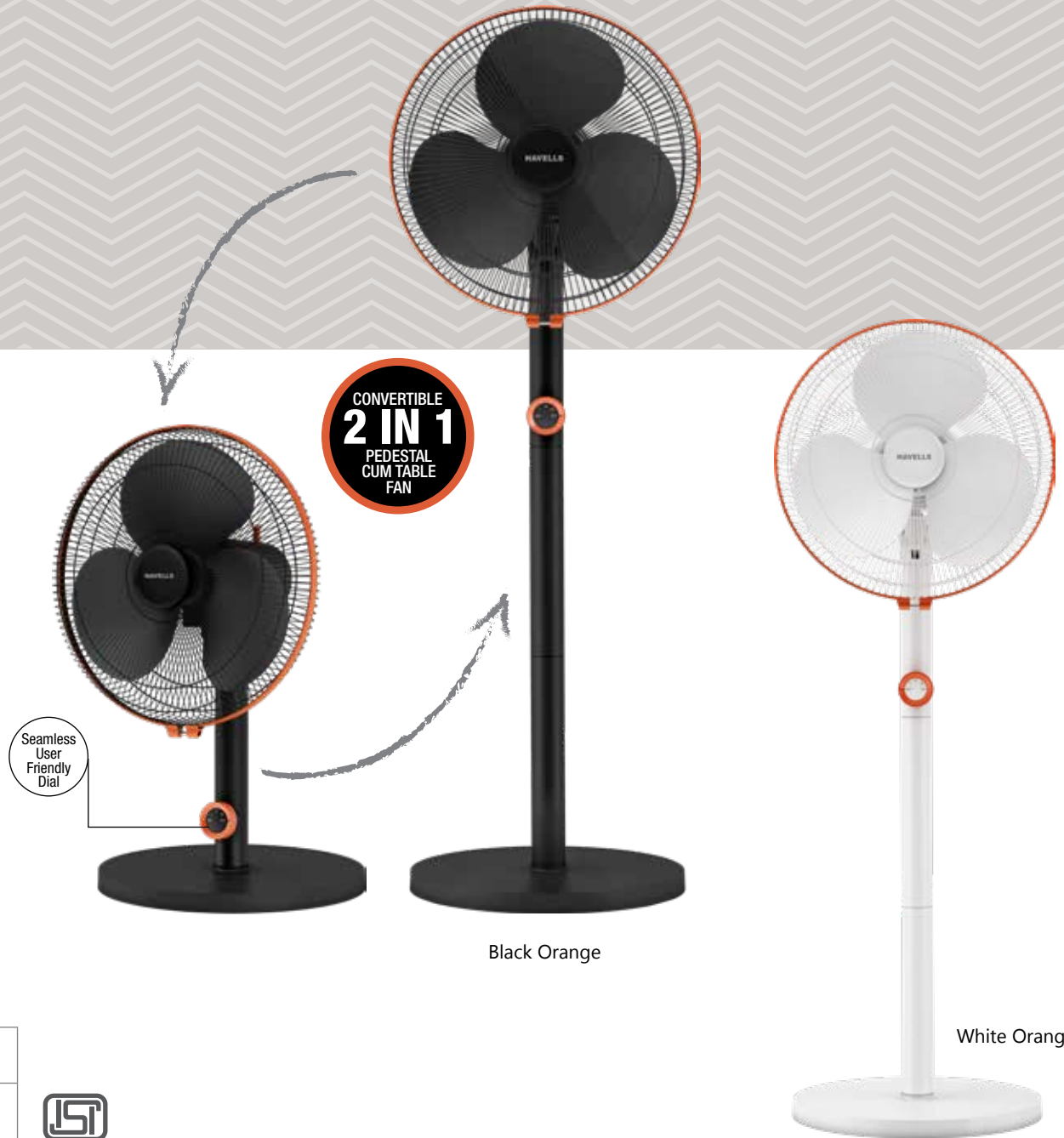

Black Orange

White Orange

STAR RATING	SWEEP	POWER INPUT	SPEED	AIR DELIVERY
NA	400 mm	65 W	1350 r/min	75 m ³ /min





AURUM



RF Remote for All Direction Sensing



Upto 8 Hours Timer Setting

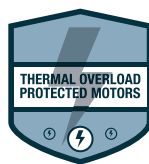

- Premium Gold Finish: Perfect Blend of Style & Functionality
- 3-Speed Settings provides Refreshing airflow
- Wide Oscillation spreads airflow across a larger area
- Sleep Mode & Breeze Mode
- Patented Quick Height Adjustment for Effortless one-touch control
- Stainless Steel Grade Pipe for High Strength & Rust Resistance

STAR RATING	SWEEP	POWER INPUT	SPEED	AIR DELIVERY
NA	400 mm	65 W	1350 r/min	75 m ³ /min

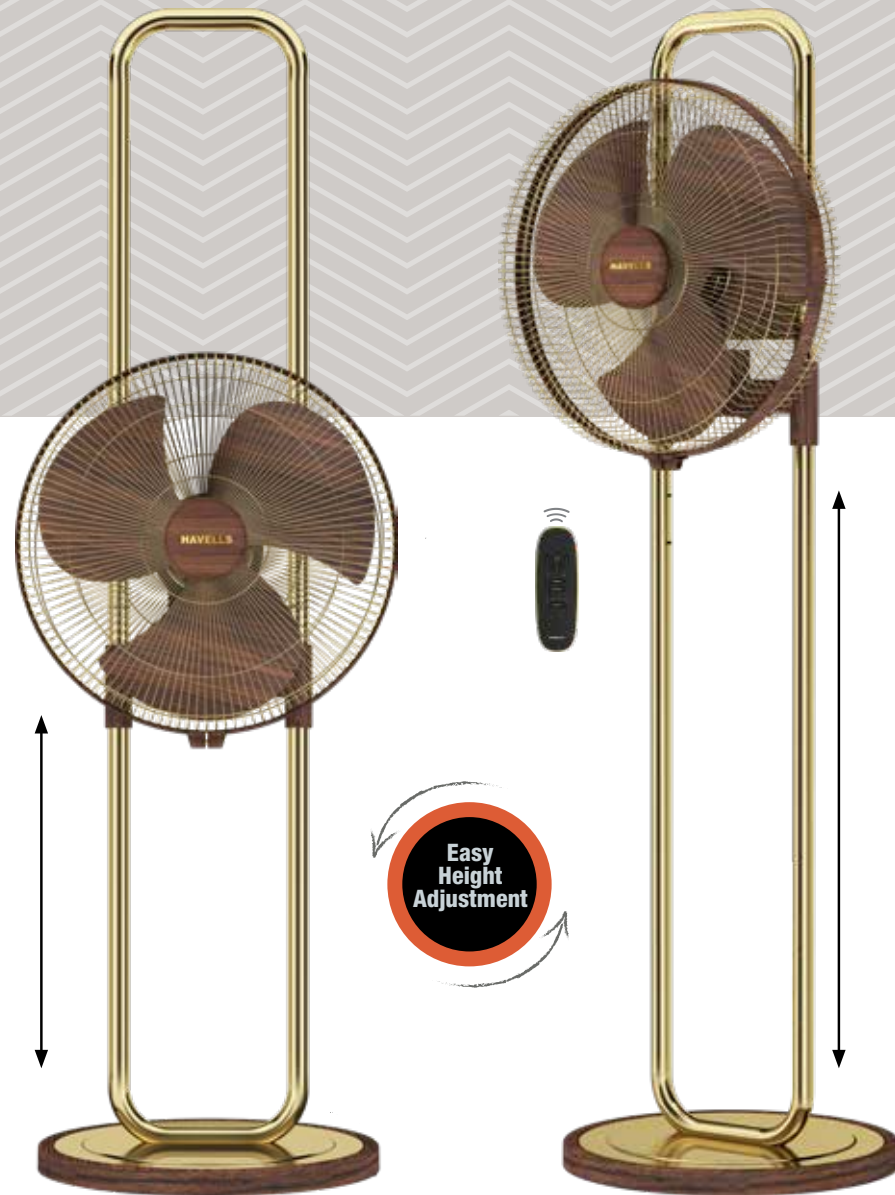

Gold



SWING PRO HS



Double Ball Bearing



- WideVolt™ Motor ensures reliable operation across wide voltage range (150 V – 265 V)
- Double Ball Bearing ensures smooth operation and long lasting motor life
- Fan Head Tilting Mechanism for Perfect Vertical Airflow Direction
- Telescopic Arrangement for Full Height Adjustment from Collet
- 3 Speed Regulation for convenience
- Jerk-Free & Smooth Oscillation
- Stainless Steel Grade Pipe for High Strength & Rust Resistance



Cherry Black



White

STAR RATING	SWEEP	POWER INPUT	SPEED	AIR DELIVERY
NA	400 mm	115 W	2150 r/min	105 m ³ /min





SWING HS



Double Ball Bearing



- WideVolt™ Motor ensures reliable operation across wide voltage range (150 V – 265 V)
- Double Ball Bearing ensures smooth operation and long lasting motor life
- Fan Head Tilting Mechanism for Perfect Vertical Airflow Direction
- Telescopic Arrangement for Full Height Adjustment from Collet
- 3 Speed Regulation for convenience
- Jerk-Free & Smooth Oscillation
- Stainless Steel Grade Pipe for High Strength & Rust Resistance

STAR RATING	SWEEP	POWER INPUT	SPEED	AIR DELIVERY
NA	400 mm	125 W	2100 r/min	95 m ³ /min



Black



White



SWING NEO



- WideVolt™ Motor ensures reliable operation across wide voltage range (150 V – 265 V)
- Fan Head Tilting Mechanism for Perfect Vertical Airflow Direction
- Telescopic Arrangement for Full Height Adjustment from Collet
- 3 Speed Regulation for convenience
- Jerk-Free & Smooth Oscillation
- Stainless Steel Grade Pipe for High Strength & Rust Resistance



Icy Blue



White Grey

STAR RATING	SWEEP	POWER INPUT	SPEED	AIR DELIVERY
NA	400 mm	65 W	1350 r/min	75 m ³ /min





SWING PRO



Double Ball Bearing

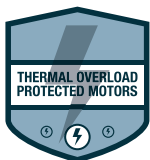

- WideVolt™ Motor ensures reliable operation across wide voltage range (150 V – 265 V)
- Double Ball Bearing ensures smooth operation and long lasting motor life
- Fan Head Tilting Mechanism for Perfect Vertical Airflow Direction
- Telescopic Arrangement for Full Height Adjustment from Collet
- 3 Speed Regulation for convenience
- Jerk-Free & Smooth Oscillation
- Stainless Steel Grade Pipe for High Strength & Rust Resistance

White



STAR RATING	SWEEP	POWER INPUT	SPEED	AIR DELIVERY
NA	400 mm	55 W	1350 r/min	82 m ³ /min



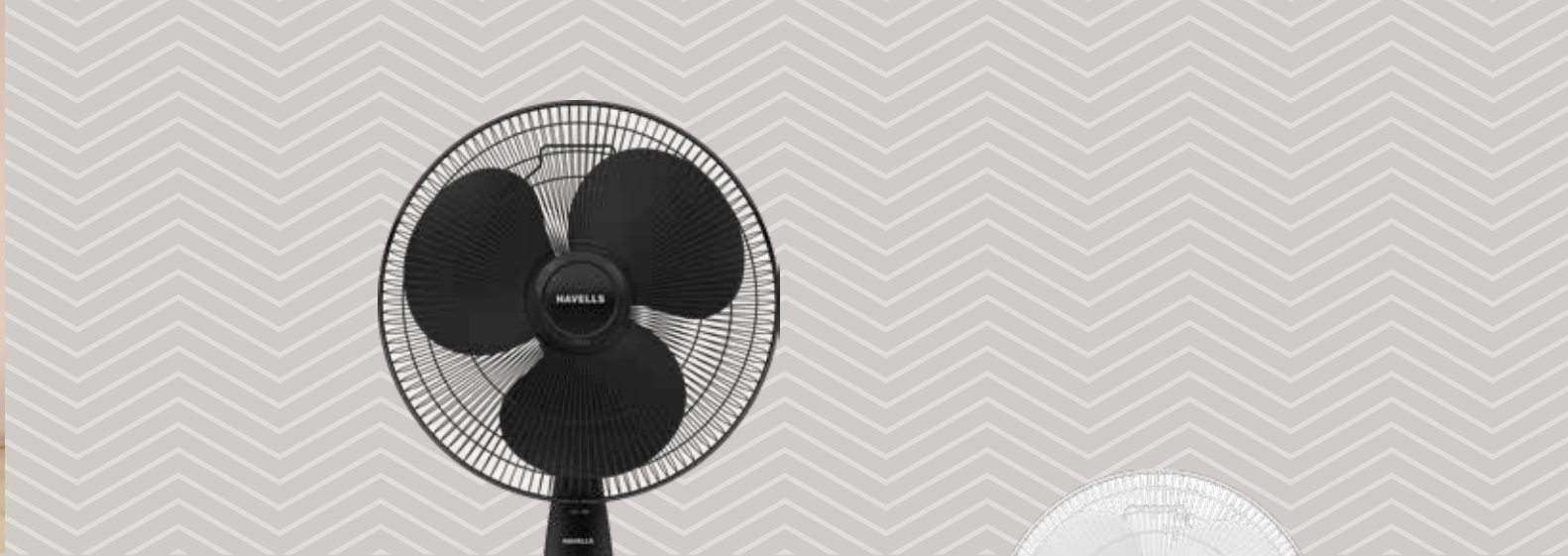

SWING



- WideVolt™ Motor ensures reliable operation across wide voltage range (150 V – 265 V)
- Fan Head Tilting Mechanism for Perfect Vertical Airflow Direction
- Telescopic Arrangement for Full Height Adjustment from Collet
- 3 Speed Regulation for convenience
- Jerk-Free & Smooth Oscillation
- Stainless Steel Grade Pipe for High Strength & Rust Resistance



Black



Off White

STAR RATING	SWEEP	POWER INPUT	SPEED	AIR DELIVERY
	400 mm	65 W	1350 r/min	75 m ³ /min





V2 ULTRA



Rust Proof
Aluminium Blades



Rotary Switch for
Speed Control



- WideVolt™ Motor ensures reliable operation across a wide voltage range (150 V – 265 V)
- Aerodynamic Metal Blade engineered for powerful airflow
- Adjustable Neck Indexing offers smooth up-and-down tilt for personalized comfort
- Telescopic Arrangement for Full Height Adjustment from Collet
- 3-Speed Rotary Switch Control for convenience
- Jerk-Free and Smooth Oscillation
- Stainless Steel Grade Pipe for High Strength & Rust Resistance

STAR RATING	SWEEP	POWER INPUT	SPEED	AIR DELIVERY
NA	450 mm	90 W	1350 r/min	110 m ³ /min



Chrome Black



Matt Black



TRENDY METALLIC



Metal blades with ribs



- Heavy-Duty Aluminium blades for high air delivery
- Sturdy Base provides enhanced stability
- Wide Oscillation spreads airflow across a larger area
- 3-Speed Switch Control for convenience
- Timer Function up to 2 hours with automatic switch-off
- Stainless Steel Grade Pipe for High Strength & Rust Resistance

STAR RATING	SWEEP	POWER INPUT	SPEED	AIR DELIVERY
NA	400 mm	57 W	1350 r/min	75 m ³ /min



Timer Function



Metallic Black



WINDSTORM PRO



Double Ball Bearing



High Air Delivery



- WideVolt™ Motor ensures reliable operation across wide voltage range (150 V – 265 V)
- Double Ball Bearing ensures smooth operation and long lasting motor life
- All Metal Body & Blade for stability & durability
- Telescopic Height Adjustment for setting vertical airflow direction
- Stainless Steel Grade Pipe for High Strength & Rust Resistance



Grey

STAR RATING	SWEEP	POWER INPUT	SPEED	AIR DELIVERY
NA	500 mm	140 W	1400 r/min	140 m ³ /min





WINDSTORM ULTRA



Double Ball Bearing



High Air Delivery



- WideVolt™ Motor ensures reliable operation across wide voltage range (150 V – 265 V)
- Double Ball Bearing ensures smooth operation and long lasting motor life
- All Metal Body & Blades for stability & durability
- Telescopic Height Adjustment for setting vertical airflow direction
- Stainless Steel Grade Pipe for High Strength & Rust Resistance



Ultra Grey



Ultra Plus - Marble Grey

STAR RATING	SWEEP	POWER INPUT	SPEED	AIR DELIVERY
NA	500 mm	140 W	1400 r/min	135 m ³ /min



Note : Also available Windstorm Ultra Plus and Windstorm Ultra-X



WINDSTORM ULTRA OXY



Double Ball Bearing



High Air Delivery



Smooth Oscillation



- Jerk Free Smooth Oscillation
- WideVolt™ Motor ensures reliable operation across wide voltage range (150 V – 265 V)
- Double Ball Bearing ensures smooth operation and long lasting motor life
- All Metal Body & Blades for stability & durability
- Telescopic Height Adjustment provides perfect vertical airflow direction
- Stainless Steel Grade Pipe for High Strength & Rust Resistance



Oscillation Button

Grey

STAR RATING	SWEEP	POWER INPUT	SPEED	AIR DELIVERY
NA	500 mm	140 W	1400 r/min	135 m ³ /min



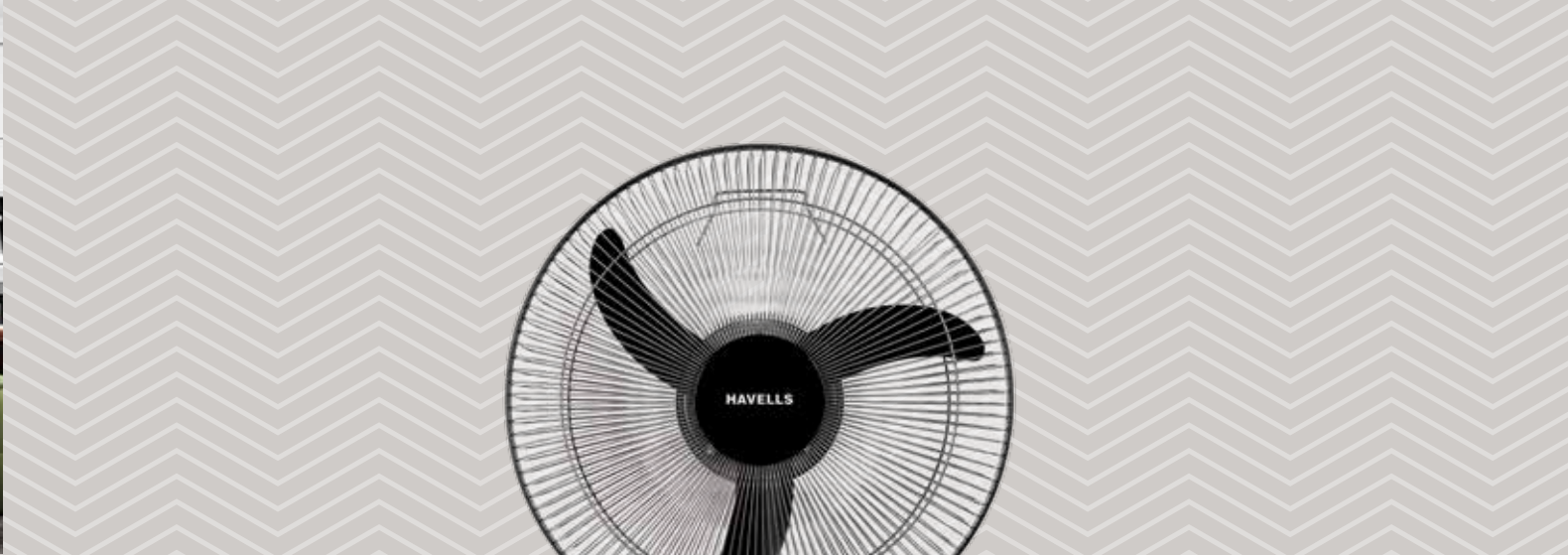

WINDSTORM OXY



Smooth Oscillation



- Unique Shape blade with High Air Delivery
- WideVolt™ Motor ensures reliable operation across wide voltage range (150 V – 265 V)
- Telescopic Height Adjustment provides perfect vertical airflow direction
- Stainless Steel Grade Pipe for High Strength & Rust Resistance



Black

STAR RATING	SWEEP	POWER INPUT	SPEED	AIR DELIVERY
NA	400 mm	115 W	2200 r/min	100 m ³ /min





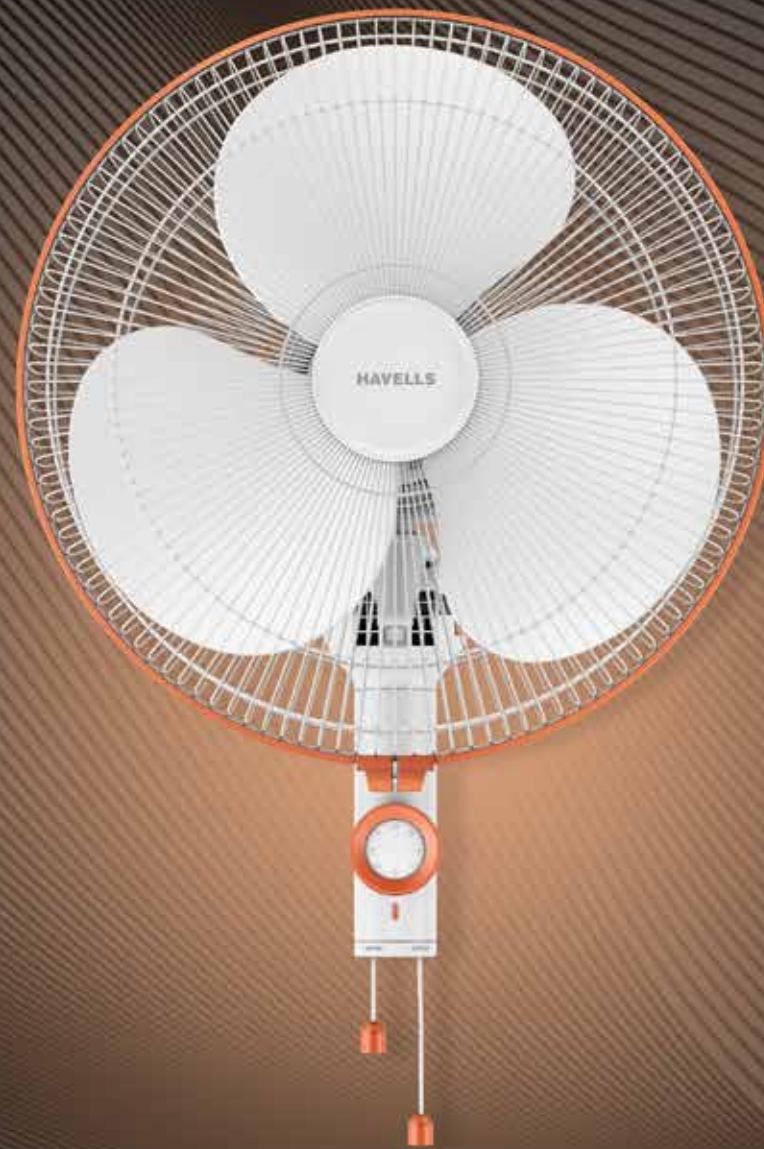

WALL
FANS

BLDC+



PLATINA BLDC



BLDC INVERTER
TECHNOLOGY



Low Power
Consumption



- WideVolt™ Motor ensures reliable operation across wide voltage range (150 V – 265 V)
- Fan Head Tilting Mechanism for Perfect Vertical Airflow Direction
- Breeze & Sleep Mode, Timer upto 8 Hours
- Jerk-Free & Smooth Oscillation

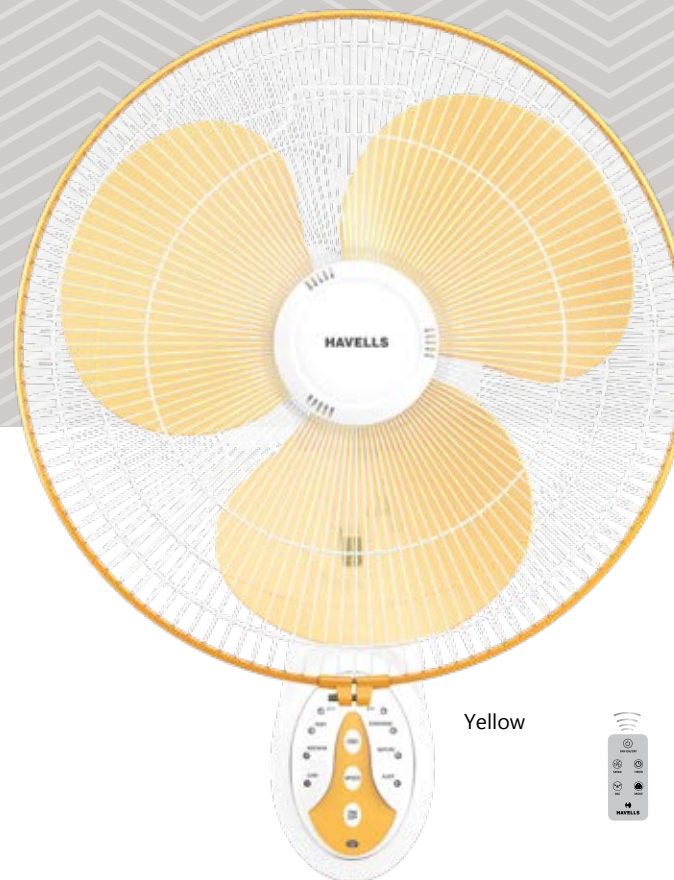

Yellow



STAR RATING	SWEEP	POWER INPUT	SPEED	AIR DELIVERY
	400 mm	30 W	1350 r/min	72 m ³ /min





PLATINA REMOTE



- I.R. Remote Control for easy control at your fingertips
- Fan Head Tilting Mechanism for Perfect Vertical Airflow Direction
- Smooth oscillation with synchronous motor
- WideVolt™ Motor ensures reliable operation across wide voltage range (150 V – 265 V)

White

STAR RATING	SWEEP	POWER INPUT	SPEED	AIR DELIVERY
NA	400 mm	65 W	1350 r/min	75 m³/min





AINDRILA PREMIUM



Square Guard



Square Guard

Brown Black

- Standard, Natural, Breeze & Sleep Mode; Timer upto 8 hours
- Soft touch option for manual operation
- ABS body for high strength and gloss
- Fan Head Tilting Mechanism for Perfect Vertical Airflow Direction
- Jerk free smooth oscillation

STAR RATING	SWEEP	POWER INPUT	SPEED	AIR DELIVERY
NA	400 mm	65 W	1350 r/min	75 m ³ /min





AIRBALL HS

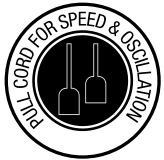

Double Ball Bearing

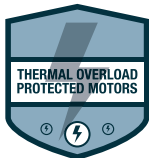

- Unique Transparent Blade for Visually stunning aesthetics
- High air delivery
- Jerk Free Smooth Oscillation
- Fan Head Tilting Mechanism for Perfect Vertical Airflow Direction

White

STAR RATING	SWEEP	POWER INPUT	SPEED	AIR DELIVERY
NA	450 mm	110 W	1750 r/min	100 m ³ /min



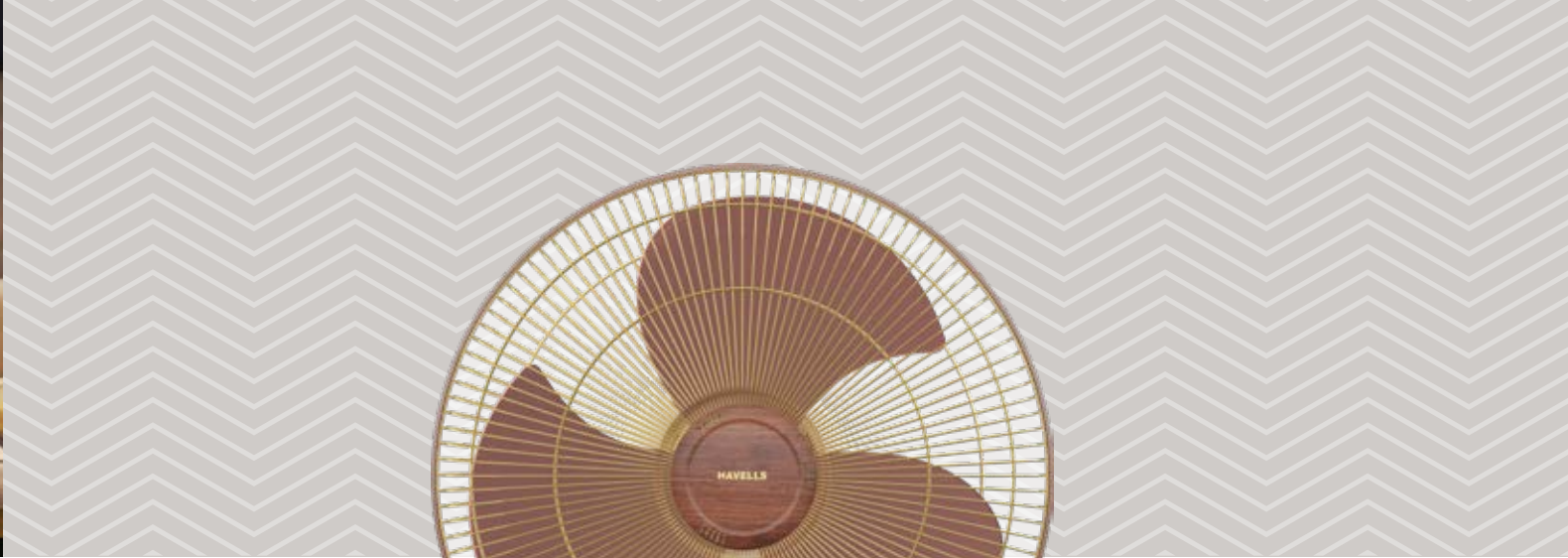

Gold Walnut

GIRIK GOLD

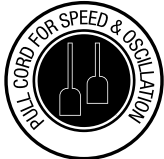

- Wooden texture body to complement room decor
- Golden guards & trim for premium looks
- Smooth oscillation

STAR RATING	SWEEP	POWER INPUT	SPEED	AIR DELIVERY
NA	400 mm	65 W	1350 r/min	75 m ³ /min





CELESTE



- Soft Dial Switch ensures Elegant and user-friendly control
- Tactile Control Dial for Convenient speed regulation and ON/OFF functionality
- Wide Oscillation spreads airflow across a larger area

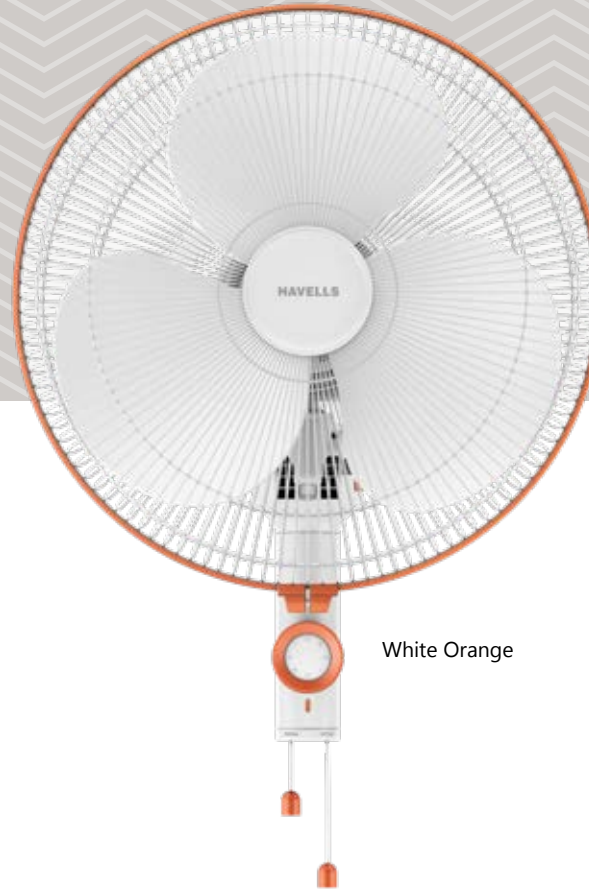

White Orange



Black Orange

STAR RATING	SWEEP	POWER INPUT	SPEED	AIR DELIVERY
NA	400 mm	65 W	1350 r/min	75 m ³ /min



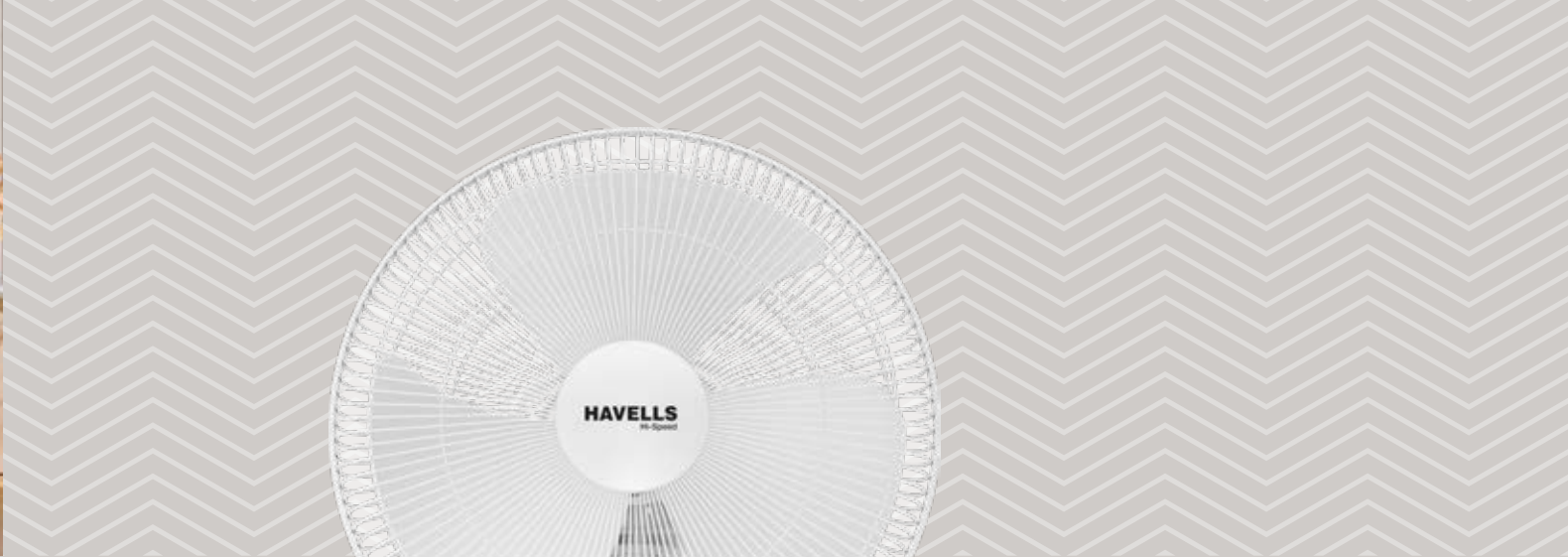

SWING PRO HS



Double Ball Bearing



- WideVolt™ Motor ensures reliable operation across wide voltage range (150 V – 265 V)
- Double Ball Bearing ensures smooth operation and long lasting motor life
- Fan Head Tilting Mechanism for Perfect Vertical Airflow Direction
- 3 Speed Regulation for convenience
- Jerk-Free & Smooth Oscillation

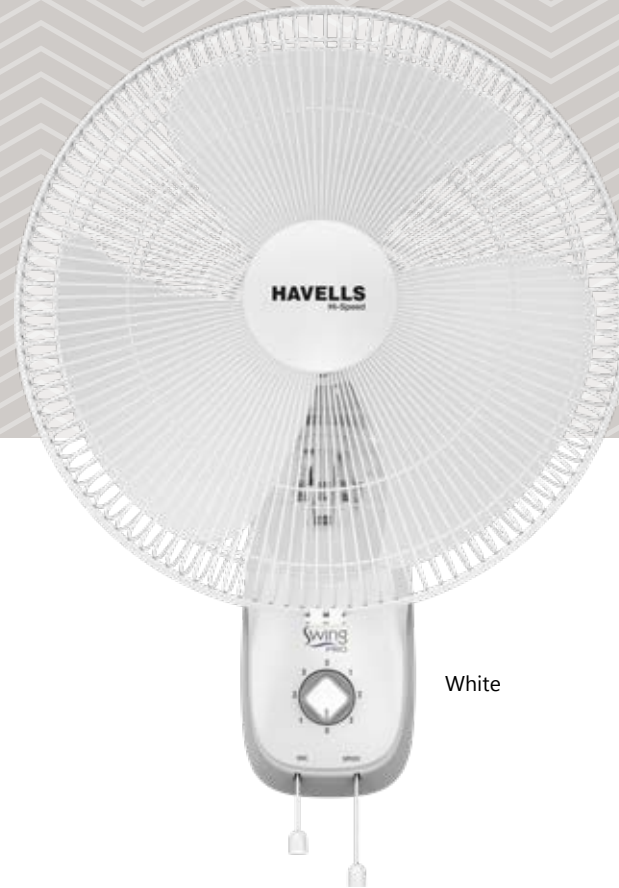

White



Cherry Black

STAR RATING	SWEEP	POWER INPUT	SPEED	AIR DELIVERY
NA	400 mm	115 W	2150 r/min	105 m ³ /min





SWING HS



Double Ball Bearing

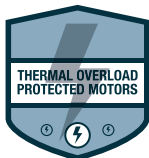

- WideVolt™ Motor ensures reliable operation across wide voltage range (150 V – 265 V)
- Double Ball Bearing ensures smooth operation and long lasting motor life
- Fan Head Tilting Mechanism for Perfect Vertical Airflow Direction
- 3 Speed Regulation for convenience
- Jerk-Free & Smooth Oscillation

STAR RATING	SWEEP	POWER INPUT	SPEED	AIR DELIVERY
NA	400 mm	125 W	2100 r/min	95 m ³ /min
NA	300 mm	105 W	2100 r/min	65 m ³ /min



Note : 300 mm is available in white color only.

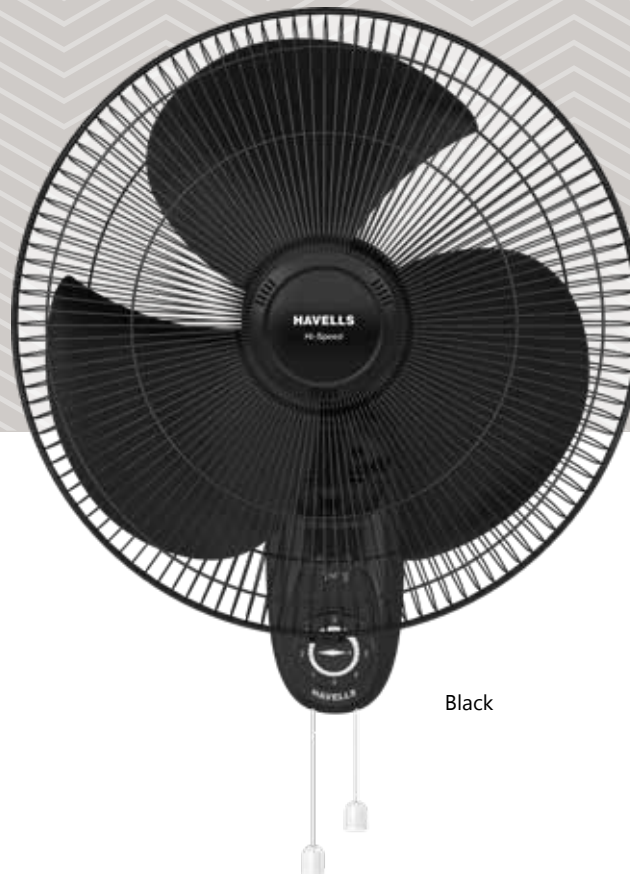

Black

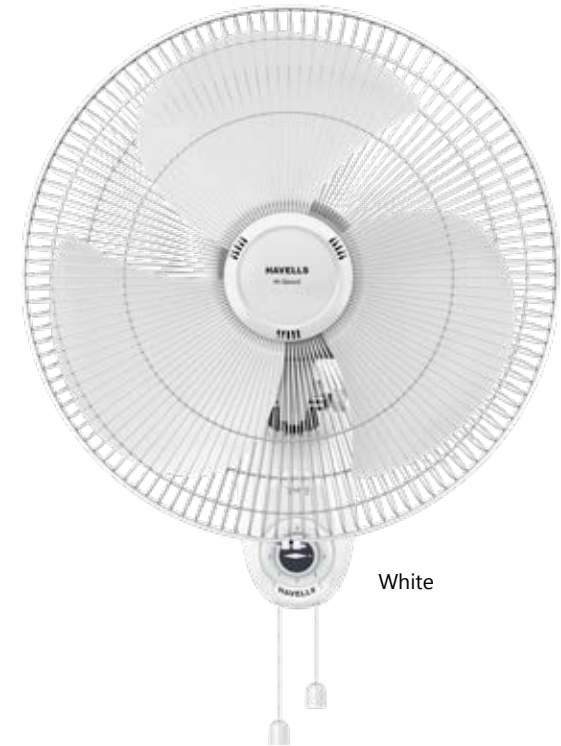

White



SWING



- WideVolt™ Motor ensures reliable operation across wide voltage range (150 V – 265 V)
- Fan Head Tilting Mechanism for Perfect Vertical Airflow Direction
- 3 Speed Regulation for convenience
- Jerk-Free & Smooth Oscillation

STAR RATING	SWEEP	POWER INPUT	SPEED	AIR DELIVERY
	400 mm	65 W	1350 r/min	75 m ³ /min
NA	300 mm	57 W	1350 r/min	55 m ³ /min

Note : 300 mm is available in off white color only.

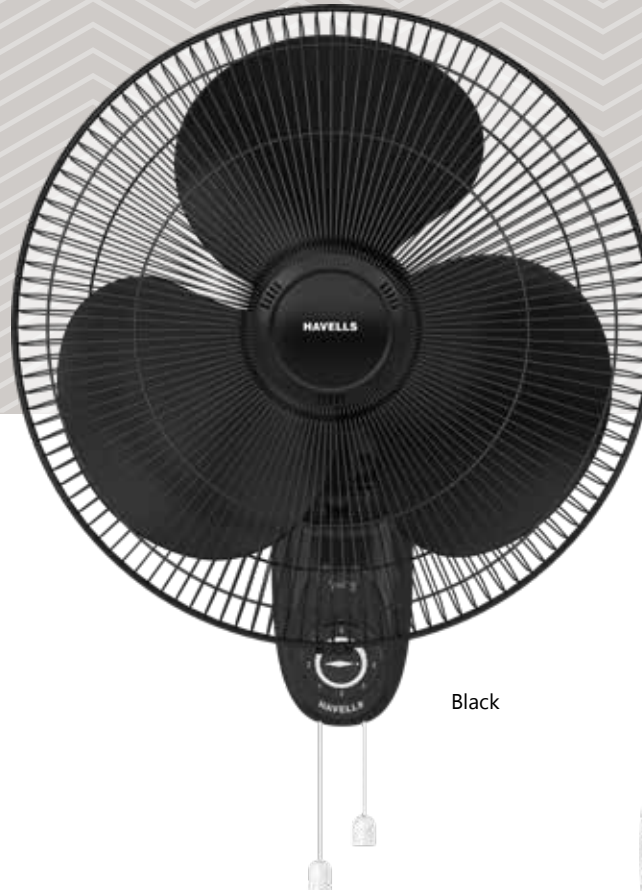

Black

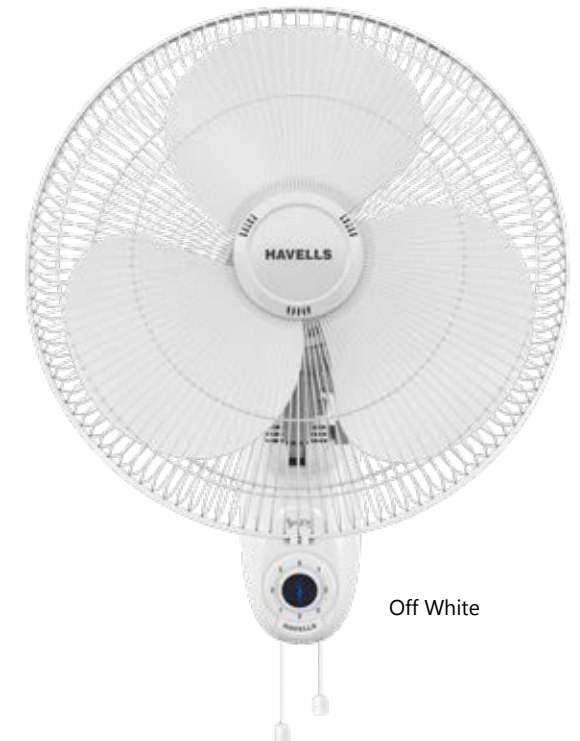

Off White



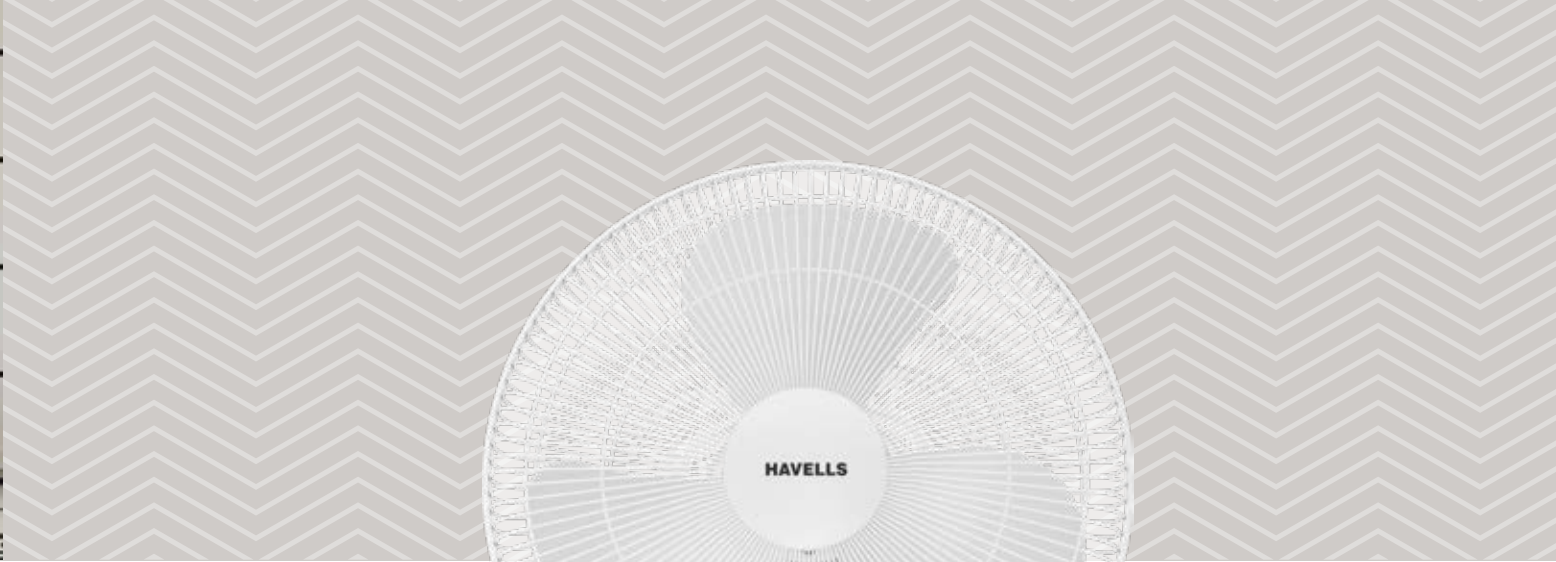

SWING PRO



Double Ball Bearing



White

- WideVolt™ Motor ensures reliable operation across wide voltage range (150 V – 265 V)
- Double Ball Bearing ensures smooth operation and long lasting motor life
- Fan Head Tilting Mechanism for Perfect Vertical Airflow Direction
- 3 Speed Regulation for convenience
- Jerk-Free & Smooth Oscillation

STAR RATING	SWEEP	POWER INPUT	SPEED	AIR DELIVERY
NA	400 mm	65 W	1350 r/min	75 m³/min





V2 ULTRA



Rust Proof
Aluminium
Blades



- WideVolt™ Motor ensures reliable operation across a wide voltage range (150 V – 265 V)
- Aerodynamic Metal Blade engineered for powerful airflow
- Adjustable Neck Indexing offers smooth up-and-down tilt for personalized comfort
- 3-Speed Rotary Switch Control for convenience
- Jerk-Free and Smooth Oscillation

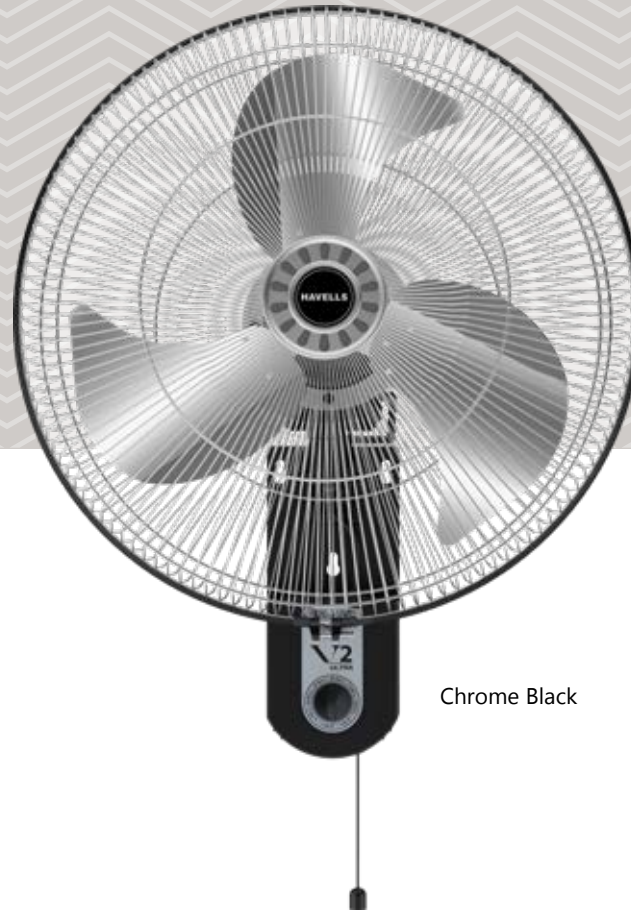

Chrome Black

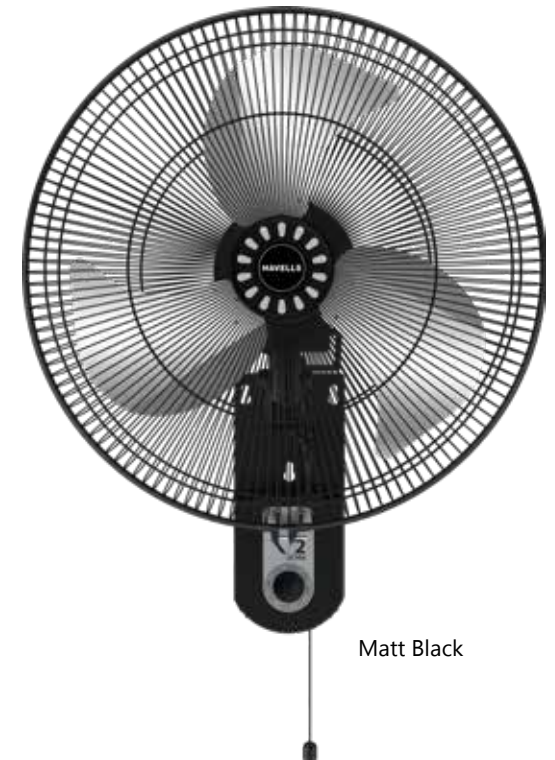

Matt Black

STAR RATING	SWEEP	POWER INPUT	SPEED	AIR DELIVERY
NA	450 mm	90 W	1350 r/min	110 m ³ /min





GIRIK NEO

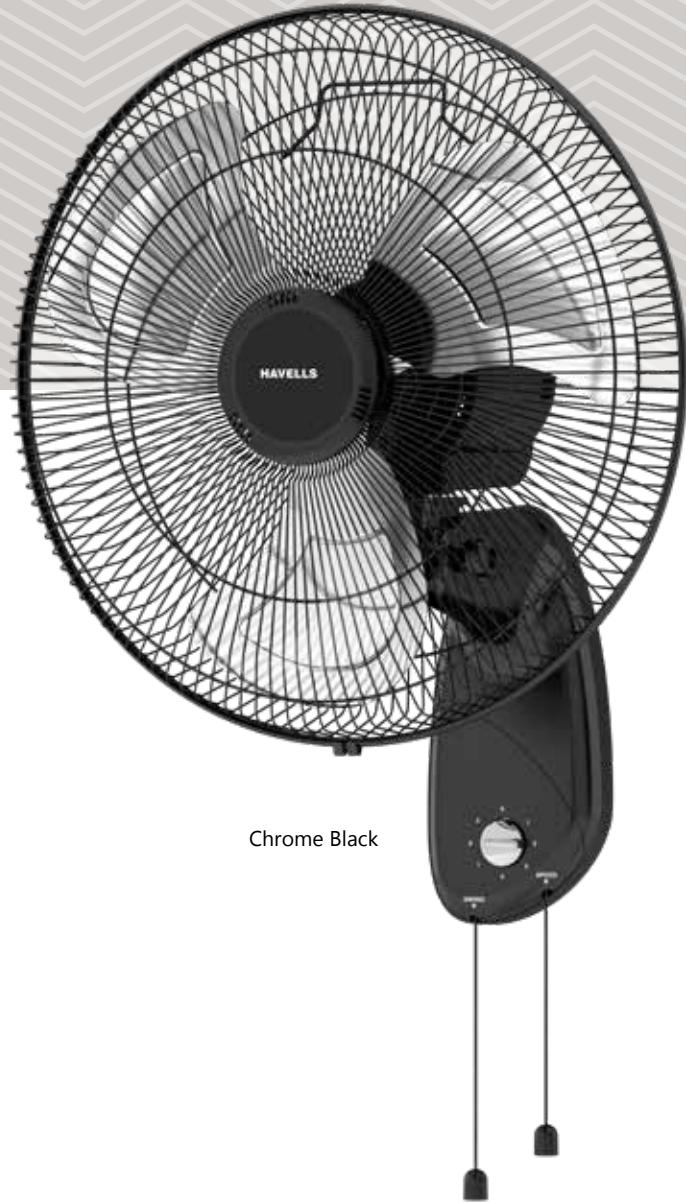

Chrome Black

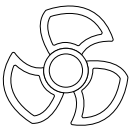

Metal blades with ribs



- Heavy-Duty Aluminium blades for high air delivery
- WideVolt™ Motor ensures reliable operation across wide voltage range (150 V – 265 V)
- 3-Speed Regulation for convenience
- Wide Oscillation spreads airflow across a larger area

STAR RATING	SWEEP	POWER INPUT	SPEED	AIR DELIVERY
NA	400 mm	65 W	1350 r/min	75 m ³ /min







PERSONAL
FANS

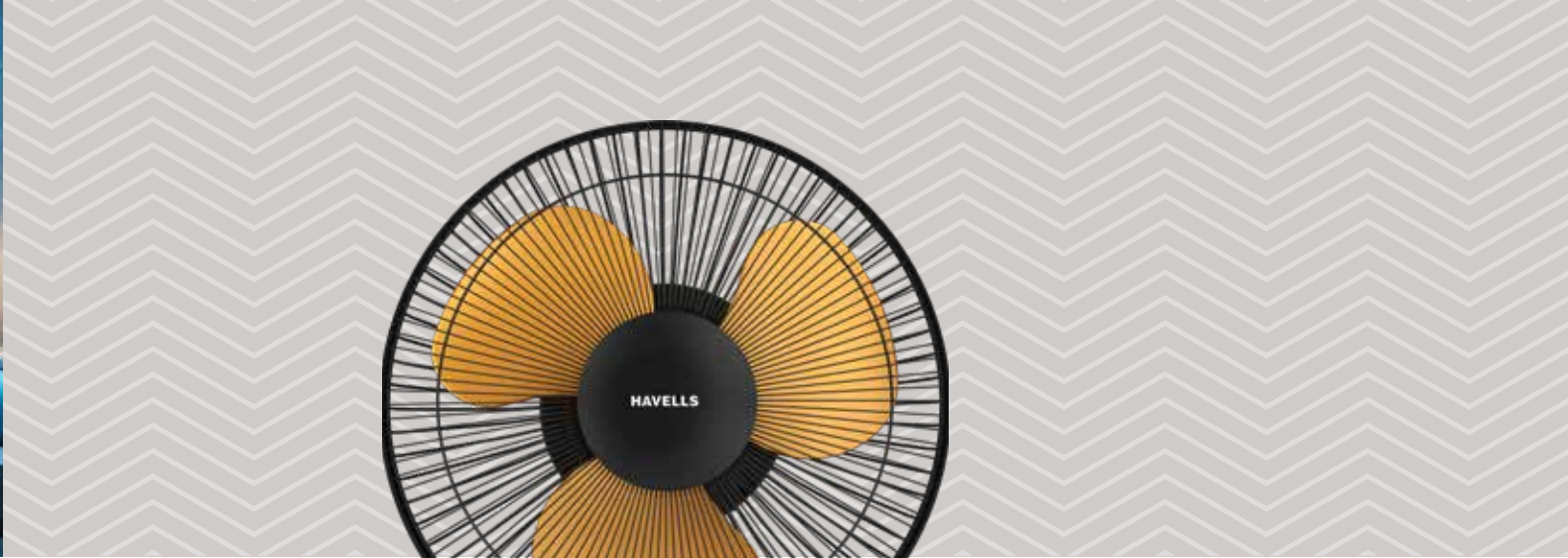

CANDY



3 Speed Control



Smooth Oscillation



HIGH SPEED

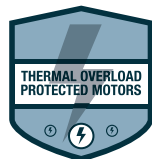

THERMAL OVERLOAD PROTECTED MOTORS



100% COPPER WIRE WINDING MOTOR

- Multi purpose fan for table & wall mounting
- Wide tilt angle for breezy feel
- WideVolt™ Motor ensures reliable operation across wide voltage range (150 V – 265 V)



Black Yellow



Black Red

STAR RATING	SWEEP	POWER INPUT	SPEED	AIR DELIVERY
NA	230 mm	60 W	2700 r/min	35 m ³ /min





BIRDIE HS



Black Grey

- Multi purpose fan suitable for desk, wall or cabin mounted application
- Jerk free oscillation and smooth operation
- Strong air blast

STAR RATING	SWEEP	POWER INPUT	SPEED	AIR DELIVERY
NA	230 mm	40 W	2800 r/min	38 m ³ /min





CRESCENT



3 Speed Control



Yellow Blue

- Table and wall mounting - dual purpose
- Revolving grill for wide spread of air
- 180° fan head movement

STAR RATING	SWEEP	POWER INPUT	SPEED	AIR DELIVERY
NA	250 mm	45 W	1320 r/min	50 m ³ /min



I COOL HS



- Multi purpose fan - can be mounted on table, wall and ceiling
- Unique multi-directional adjustment for desired air flow
- Unique propeller, deep pitched blades for powerful air flow



Black Grey



On wall



On Table



On Ceiling

STAR RATING	SWEEP	POWER INPUT	SPEED	AIR DELIVERY
NA	175 mm	55 W	2000 r/min	40 m ³ /min



Off White

CIERA HS

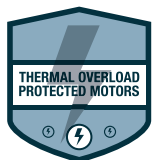

- Grill for protection
- Ideal for mounting on low height ceiling and in cabin



White

STAR RATING	SWEEP	POWER INPUT	SPEED	AIR DELIVERY
NA	300 mm	85 W	2200 r/min	75 m ³ /min
NA	230 mm	60 W	2700 r/min	60 m ³ /min





AIRWYNN

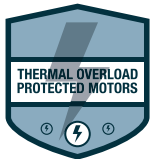

White



- Ideal for mounting on low height ceiling and in cabin
- Rotating grill for smooth air circulation

STAR RATING	SWEEP	POWER INPUT	SPEED	AIR DELIVERY
NA	300 mm	80 W	2200 r/min	60 m ³ /min





HAVELLS

VENTIL AIR FANS







VENTIL AIR DXZ NEO



Off White



Black

- Circular Design for Easy Installation on Glass Window, Wooden Panels & Wall
- Protective Grill – Front & Back for Enhanced Safety
- Detachable Front Grill for Easy Cleaning
- Strong Suction quickly removes Smoke, Dust & Odour

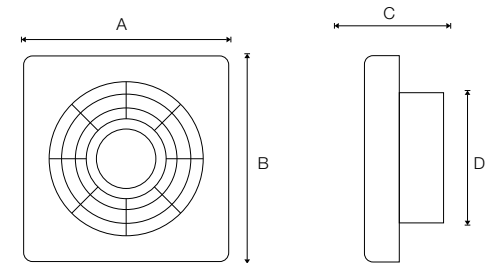

SWEEP	A	B	C	D
150 mm	178 mm	178 mm	106 mm	150 mm

SWEEP	POWER INPUT	SPEED	AIR DELIVERY	RATED VOLTAGE	RATED FREQUENCY	NOISE LEVEL
150 mm	20 W	2100 r/min	250 m ³ /h	230 V	50 Hz	45 dB



VENTIL AIR LX WS



Ivory



- Automatic Front Shutter Protects Insects and Dust entry
- Back Circular Ring ensures Tight Fitting for Secure Installation
- Modular Concept Hidden Blades to match the Décor Seamlessly
- Circular Design for Easy Installation on Glass Window, Wooden Panels & Wall
- Removable Front Frame for Easy Cleaning & Better Maintenance
- Silent Operation: Remarkably Quieter than Regular Exhaust Fans
- ABS Body: Visually Elegant & Aesthetic

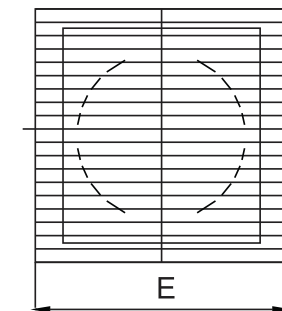
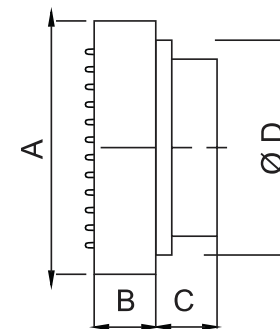

SWEEP	POWER INPUT	SPEED	AIR DELIVERY	RATED VOLTAGE	RATED FREQUENCY	NOISE LEVEL
150 mm	22 W	2000 r/min	275 m ³ /h	230 V	50 Hz	50 dB

SWEEP	A	B	C	D	E
150 mm	208 mm	21 mm	90 mm	150 mm	208 mm



VENTIL AIR LX



- Protective Front Shutter for Safety
- Circular Design for Easy Installation on Glass Window, Wooden Panels & Wall
- Removable Front Frame for easy cleaning
- ABS Body : Visually Elegant & Aesthetic
- Back Side ring for tight fitting
- Auto Back Shutter for protection against dust & insects



Off White

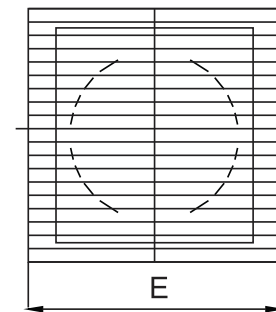
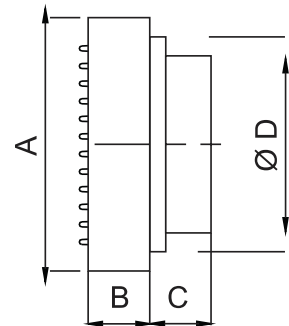

Back Shutter

SWEEP	A	B	C	D	E
200 mm	255 mm	22 mm	90 mm	200 mm	255 mm
150 mm	208 mm	21 mm	90 mm	150 mm	208 mm

SWEEP	POWER INPUT	SPEED	AIR DELIVERY	RATED VOLTAGE	RATED FREQUENCY	NOISE LEVEL
200 mm	35 W	1800 r/min	690 m ³ /h	230 V	50 Hz	50 dB
150 mm	22 W	2000 r/min	275 m ³ /h	230 V	50 Hz	50 dB

Note: Back shutter is available in 150 mm only.



VENTIL AIR ZX

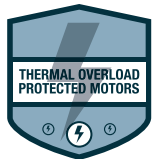

- Flat Fully Covered Concealed Frame : Designed to match the Décor Seamlessly
- Quiet Performance than Regular Exhaust Fans
- Circular Design for Easy Installation on Glass Window, Wooden Panels & Wall
- Removable, screwless front for easy cleaning and maintenance
- Protective Grill – Back for Enhanced Safety
- ABS Body : Visually Elegant & Aesthetic



Off White



Front View

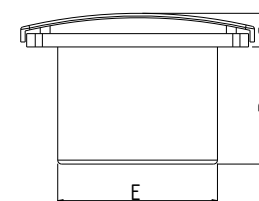
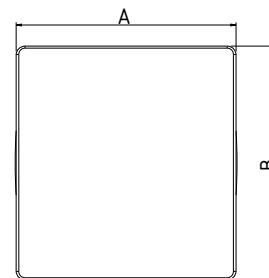

SWEEP	A	B	C	D	E
150 mm	194 mm	194 mm	28 mm	124 mm	145 mm

SWEEP	POWER INPUT	SPEED	AIR DELIVERY	RATED VOLTAGE	RATED FREQUENCY	NOISE LEVEL
150 mm	25 W	2000 r/min	275 m ³ /h	230 V	50 Hz	42 dB



VENTIL AIR HUSH

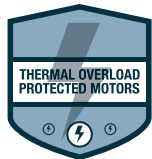

- Modular Concept for Hidden Blades to match the Décor Seamlessly
- Quiet Performance than Regular Exhaust Fans
- Circular Design for Easy Installation on Glass Window, Wooden Panels & Wall
- Removable front plate for easy cleaning and maintenance
- Protective Grill – Back for Enhanced Safety
- ABS Body : Visually Elegant & Aesthetic



Ivory



Steel Finish



American Walnut

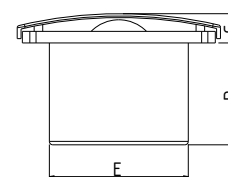
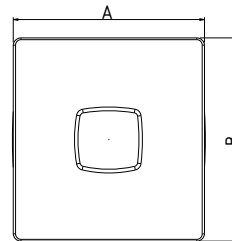

SWEEP	A	B	C	D	E
150 mm	200 mm	200 mm	28 mm	94 mm	145 mm
100 mm	150 mm	150 mm	27 mm	72 mm	98 mm

SWEEP	POWER INPUT	SPEED	AIR DELIVERY	RATED VOLTAGE	RATED FREQUENCY	NOISE LEVEL
150 mm	25 W	2000 r/min	275 m ³ /h	230 V	50 Hz	40 dB
100 mm	15 W	2450 r/min	140 m ³ /h	230 V	50 Hz	35 dB

Note: 100 mm available in Ivory color only.



VENTIL AIR ZXR

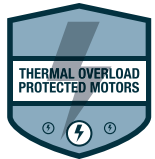

- Round Head for Easy Installation on Glass Window, Wooden Panels & Wall
- Pull Cord ON/OFF for Enhanced Convenience & Accessibility
- Modular Concept: Round Head to match the Décor Seamlessly
- Back Flap To Prevent Entry of Insects, Pests, Rodents and Dust
- Silent Operation: Remarkably Quieter than Regular Exhaust Fans
- ABS Body: Visually Elegant & Aesthetic

SWEEP	POWER INPUT	SPEED	AIR DELIVERY	RATED VOLTAGE	RATED FREQUENCY	NOISE LEVEL
150 mm	26 W	1800 r/min	400 m ³ /h	230 V	50 Hz	45 dB

Sweep	A	B	C	D	E	F	G	H
150 mm	210 mm	150 mm	80 mm	72 mm	35 mm	32 mm	180 mm	142 mm



White

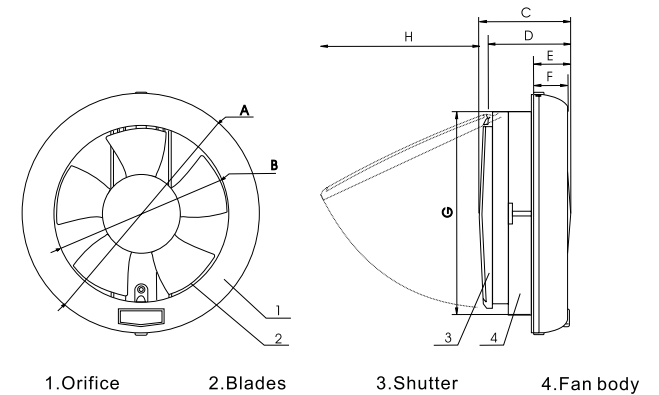



VENTIL AIR ZXC

CEILING EXHAUST



Off-White

- Perfectly fits in 20.32 cm x 20.2 cm false ceiling with 25.4 cm x 25.4 cm Outer Diameter
- False Ceiling Mount: can be mounted without drilling holes in walls or glass
- Modular Concept: Hidden Blades & Seamless Finish
- Removable Front Frame for Easy Cleaning & Maintenance
- Quiet Performance than Regular Exhaust Fans

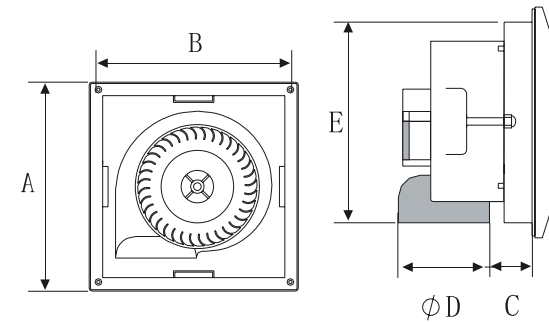

SWEEP	A	B	C	D	E
100 mm	235 mm	213 mm	30 mm	95 mm	200 mm

SWEEP	POWER INPUT	SPEED	AIR DELIVERY	RATED VOLTAGE	RATED FREQUENCY	NOISE LEVEL
100 mm	26 W	1400 r/min	74 m ³ /h	230 V	50 Hz	45 dB



THRILL AIR DLX



6 Blades for High Air Delivery



- WideVolt™ Motor ensures reliable operation across wide voltage range (150 V – 265 V)
- High Air Delivery quickly removes Smoke, Dirt & Odour
- Automatic Back Shutter provides Protection from Dust, Insects & Birds
- Rust Free Body & Blades for Easy Maintenance
- Easy to Mount for Hassle Free Installation



White

Automatic Back Shutter to Prevent Insect Entry



SWEEP	A	B	C	D	E	F
250 mm	250 mm	344 mm	312 mm	291 mm	69 mm	115 mm
200 mm	200 mm	294 mm	262 mm	241 mm	70 mm	101 mm
150 mm	150 mm	244 mm	212 mm	191 mm	65 mm	125 mm

SWEEP	POWER INPUT	SPEED	AIR DELIVERY	RATED VOLTAGE	RATED FREQUENCY
250 mm	36 W	1320 r/min	900 m ³ /h	230 V	50 Hz
200 mm	28 W	1350 r/min	600 m ³ /h	230 V	50 Hz
150 mm	24 W	1400 r/min	300 m ³ /h	230 V	50 Hz



THRILL AIR DX



White

Automatic Back Shutter to Prevent Insect Entry

- Big Sized Blade: Powerful Ventilation
- High Air Delivery quickly removes Smoke, Dirt & Odour
- Automatic Back Shutter for Protection from Dust, Insects & Birds
- Auto Thermal Protector Protects Motor against Thermal Overload
- Rust Free Body & Blades for Easy Maintenance
- Easy to Mount for Hassle Free Installation

SWEEP	POWER INPUT	SPEED	AIR DELIVERY	RATED VOLTAGE	RATED FREQUENCY	NOISE LEVEL
300 mm	60 W	1000 r/min	1130 m ³ /h	230 V	50 Hz	50 dB



VENTIL AIR DX



Off-White



Black

- Auto Back Shutter for protection from Dust, Insects and Birds
- Detachable Oil Tray for Easy Cleaning
- High quality engineering plastic, resistant to colour change

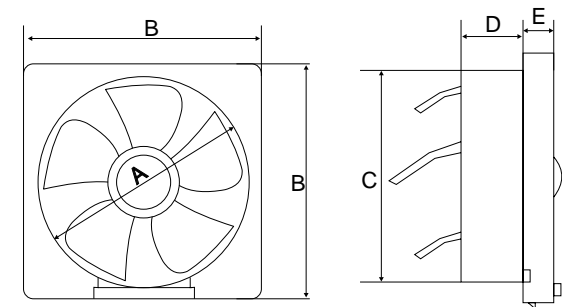

SWEEP	A	B	C	D	E
150 mm	150 mm	241 mm	172 mm	73 mm	50 mm
200 mm	200 mm	298 mm	240 mm	90 mm	40 mm
250 mm	250 mm	348 mm	290 mm	90 mm	48 mm

SWEEP	POWER INPUT	SPEED	AIR DELIVERY	RATED VOLTAGE	RATED FREQUENCY	NOISE LEVEL
150 mm	25 W	1350 r/min	280 m ³ /h	230 V	50 Hz	40 dB
200 mm	32 W	1350 r/min	520 m ³ /h	230 V	50 Hz	45 dB
250 mm	35 W	1200 r/min	860 m ³ /h	230 V	50 Hz	48 dB



VENTIL AIR DX HS

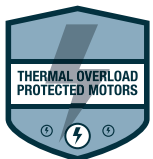

Off-White

- Auto Back Shutter for Protection from Dust, Insects & Birds
- Detachable Oil Tray for Easy Cleaning
- High quality engineering plastic, resistant to colour change

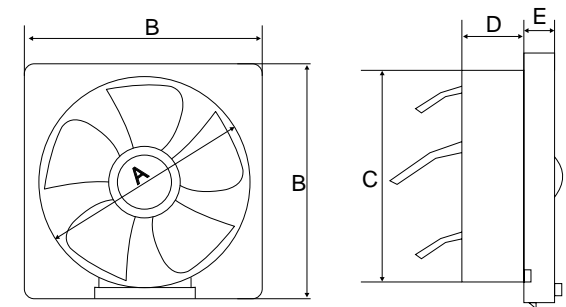

SWEEP	A	B	C	D	E
150 mm	150 mm	241 mm	172 mm	73 mm	50 mm
200 mm	200 mm	298 mm	240 mm	90 mm	40 mm

SWEEP	POWER INPUT	SPEED	AIR DELIVERY	RATED VOLTAGE	RATED FREQUENCY	NOISE LEVEL
150 mm	30 W	2300 r/min	600 m ³ /h	230 V	50 Hz	60 dB
200 mm	65 W	2000 r/min	850 m ³ /h	230 V	50 Hz	60 dB



VENTIL AIR DSP



Choco Brown

- Strong Metal Body
- Rust-Free Bird Guard provides Longevity with Safety
- WideVolt™ Motor ensures reliable operation across wide voltage range (150 V – 265 V)
- Easy Mounting for Hassle-free installation
- Powerful Suction quickly removes Smoke, Dirt & Odour
- Powder-Coated Finish provides long-lasting performance and Premium Look

SWEEP	POWER INPUT	SPEED	AIR DELIVERY	RATED VOLTAGE	RATED FREQUENCY	NOISE LEVEL
230 mm	40 W	1400 r/min	800 m³/h	230 V	50 Hz	45 dB - 50 dB
300 mm	50 W	1400 r/min	1200 m³/h	230 V	50 Hz	45 dB- 50 dB



VENTIL AIR DSP METAL



- Strong Metal Body
- WideVolt™ Motor ensures reliable operation across wide voltage range (150 V – 265 V)
- Rust-Free Bird Guard provides Longevity with Safety
- Easy Mounting for Hassle-free installation
- Powerful Suction quickly removes Smoke, Dirt & Odour
- Powder-Coated Finish provides Long-lasting performance and Premium Look

Pista Green

SWEEP	POWER INPUT	SPEED	AIR DELIVERY	RATED FREQUENCY	NOISE LEVEL
150 mm	30 W	1400 r/min	300 m ³ /h	50 Hz	45 dB - 50 dB
230 mm	40 W	1400 r/min	800 m ³ /h	50 Hz	45 dB - 50 dB
300 mm	50 W	1400 r/min	1200 m ³ /h	50 Hz	45 dB- 50 dB



VENTIL AIR DS HS METAL

REVERSIBLE



Grey



Bed Switch for reversible Airflow

- Reversible Air Flow: Ability to expel indoor air and draw in fresh air from outside
- WideVolt™ Motor ensures reliable operation across wide voltage range (150 V – 265 V)
- Strong Metal Body Prevents entry of insects
- Rust Free Bird Guard for Easy Installation on Glass Window, Wooden Panels & Wall
- Strong Suction provides Durable & Robust Performance
- Powder Coated Long Lasting Finish

SWEEP	POWER INPUT	SPEED	AIR DELIVERY	RATED VOLTAGE	RATED FREQUENCY	NOISE LEVEL
230 mm	65 W	2300 r/min	1050 m³/h	230 V	50 Hz	70 dB
300 mm	75 W	2300 r/min	1533 m³/h	230 V	50 Hz	68 dB



VENTIL AIR DB METAL



Double Ball Bearing

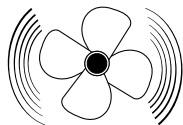

High Air Delivery

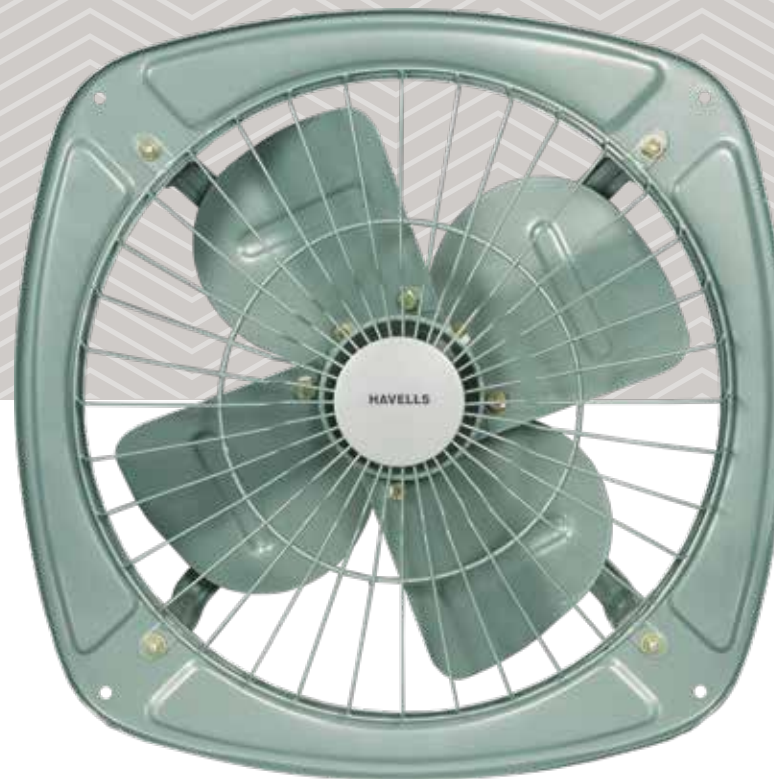

Pista Green

- Strong Metal Body
- Double Ball Bearing ensures smooth and quiet operation by reducing friction and wear
- WideVolt™ Motor ensures reliable operation across wide voltage range (150 V – 265 V)
- Rust Free Bird Guard Prevents any contact with the blades
- Strong Suction provides Durable & Robust Performance
- Powder Coated Long Lasting Finish

SWEEP	POWER INPUT	SPEED	AIR DELIVERY	RATED VOLTAGE	RATED FREQUENCY	NOISE LEVEL
230 mm	45 W	1400 r/min	860 m ³ /h	230 V	50 Hz	45 dB - 50 dB
300 mm	70 W	1400 r/min	1850 m ³ /h	230 V	50 Hz	45 dB - 50 dB

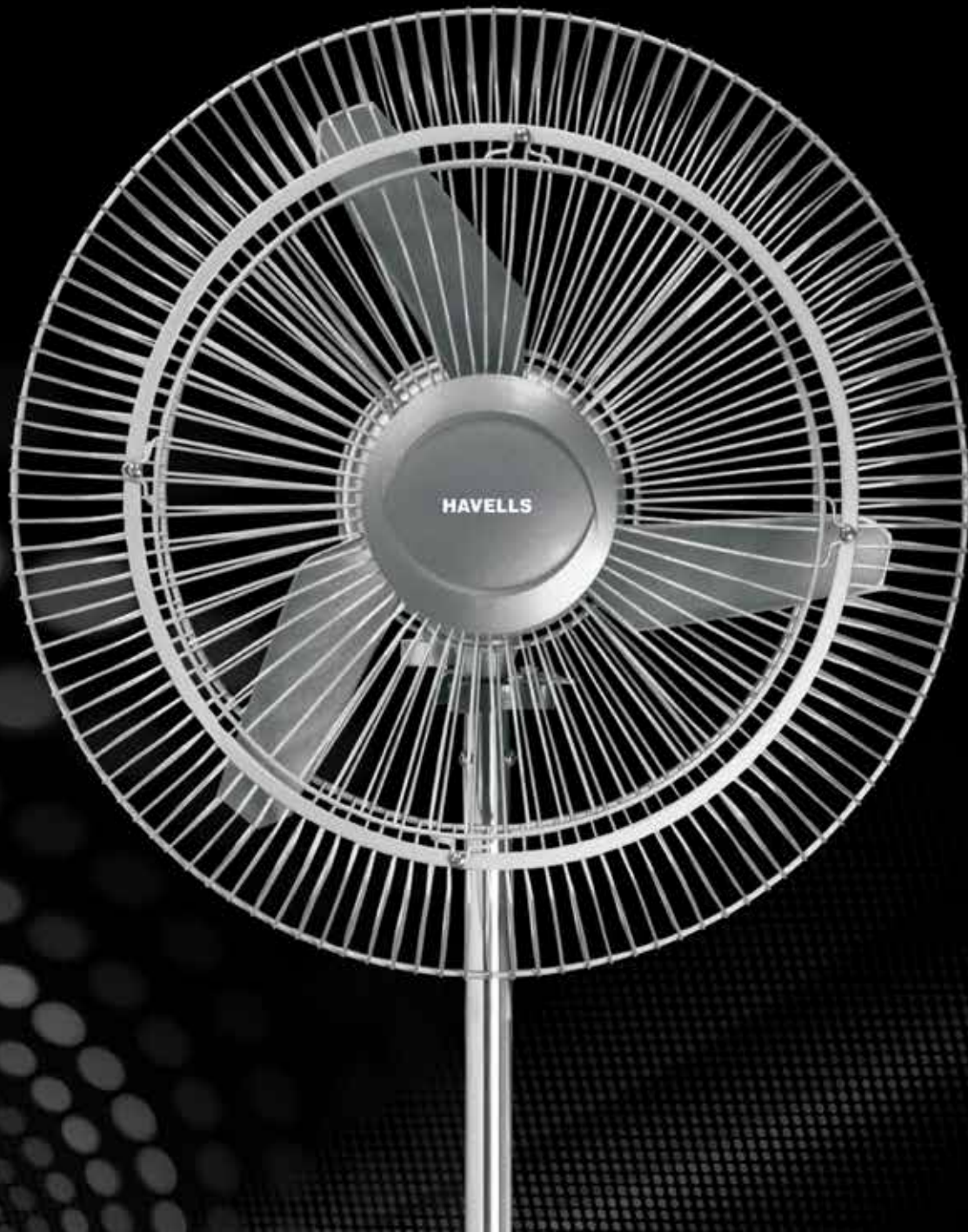

INDUSTRIAL FANS





TURBO FORCE DX HEAVY DUTY EXHAUST FAN



Double Ball
Bearing

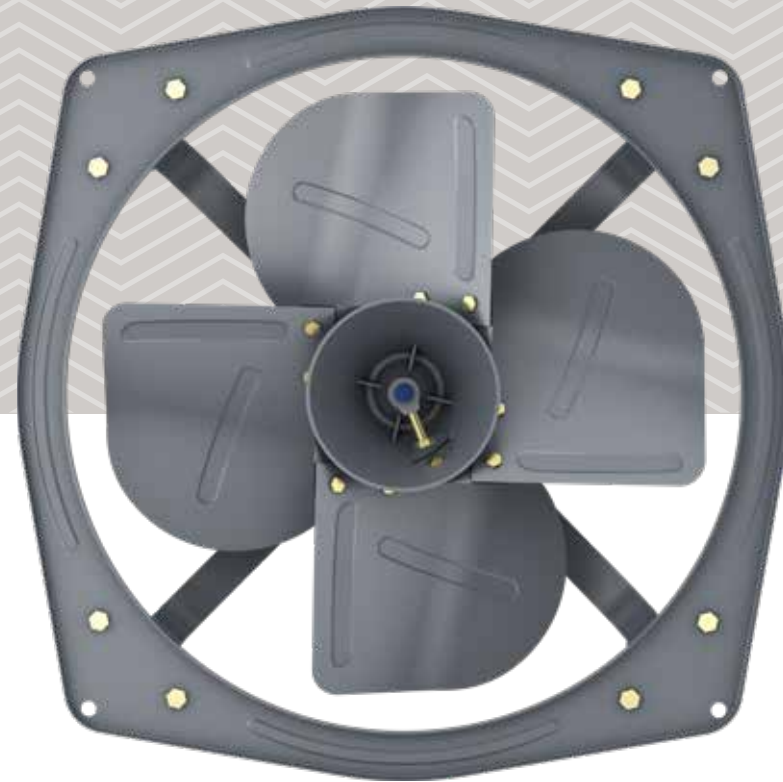

Grey

- WideVolt™ Motor – Ensures reliable operation across a wide voltage range (150 V – 265 V)
- IS 2312: Performance plus Safety Standard with constant Air Delivery
- IP 55: Strong protection against dust and low-pressure water jets
- Heavy Duty Motor: Long lasting Performance for Industrial Usage
- Double Ball Bearing: Noiseless Operation
- Aerodynamically balanced impellers & blade: Smooth & vibration-free operation
- Silent Operation: Rigid frame with rubber mountings





TECHNICAL SPECIFICATIONS

SWEEP	POWER INPUT	SPEED	AIR DELIVERY	PHASE	CURRENT	NOISE LEVEL
300 mm	95 W	1400 r/min	1950 m ³ /h	1 Phase	0.3 A	60 dB – 65 dB
380 mm	175 W	1400 r/min	3700 m ³ /h	1 Phase	0.7 A	65 dB – 70 dB
450 mm	385 W	1400 r/min	6200 m ³ /h	1 Phase	1.3 A	70 dB – 75 dB
600 mm	500 W	900 r/min	10520 m ³ /h	1 Phase	1.9 A	70 dB – 75 dB
300 mm	60 W	900 r/min	1275 m ³ /h	1 Phase	0.2 A	60 dB – 65 dB
380 mm	110 W	900 r/min	2250 m ³ /h	1 Phase	0.4 A	65 dB – 70 dB
450 mm	160 W	900 r/min	4400 m ³ /h	1 Phase	0.6 A	70 dB – 75 dB

DIMENSIONAL SPECIFICATIONS

Sweep	Ø H mm	X mm	YSQ mm	Ø S mm
300 mm	7.7 mm	390 mm	310 mm	320 mm
380 mm	10.5 mm	460 mm	375 mm	400 mm
450 mm	10.5 mm	550 mm	440 mm	485 mm
600 mm	10.5 mm	720 mm	605 mm	635 mm

General tolerance of +- 5 mm

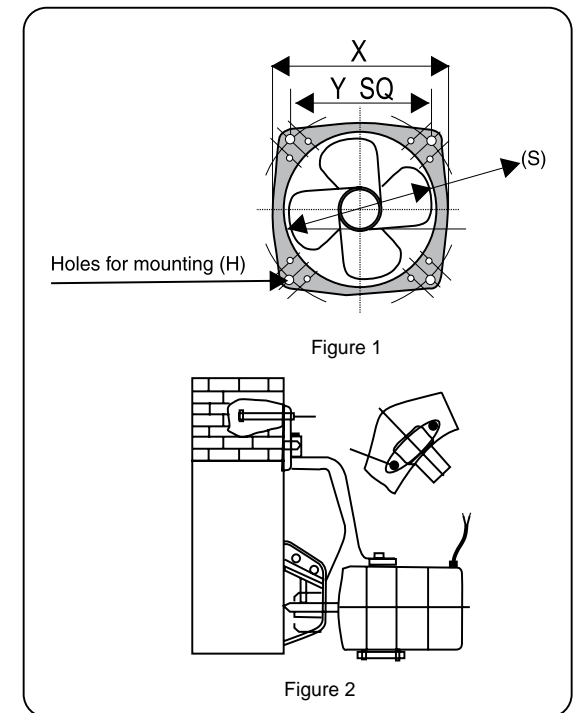

Tolerance on ratings (As per IS 2312-1967)

Speed	-5% to +10%
Power	+10%
Air Delivery	-10%

At 230 V, 1 Phase, 50 Hz AC
or 400 V, 3 Phase, 50 Hz AC

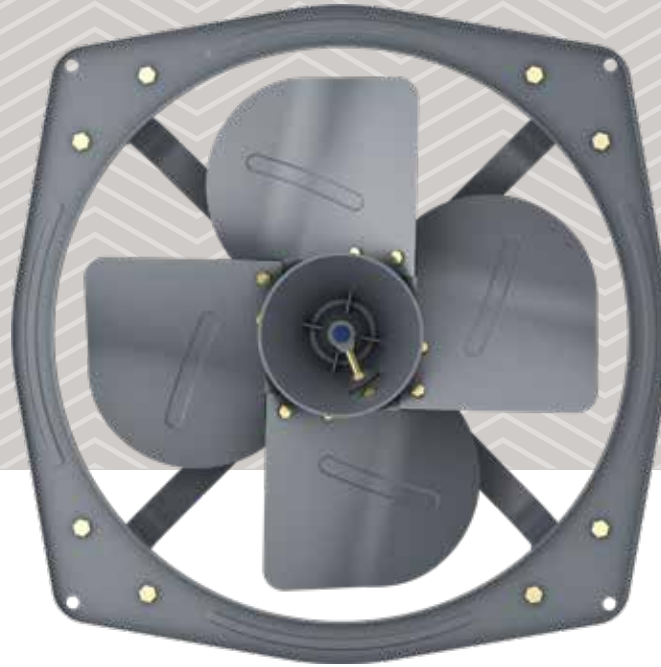

Grey

TURBO FORCE NX

HEAVY DUTY EXHAUST FAN



Double Ball Bearing



- WideVolt™ Motor – Ensures reliable operation across a wide voltage range (150 V – 265 V)
- IS 302: Safety Standard
- IP 55: Strong protection against dust and low-pressure water jets
- Heavy Duty Motor: Long lasting Performance for Industrial Usage
- Double Ball Bearing: Noiseless Operation
- Aerodynamically balanced impellers & blade: Smooth & vibration-free operation
- Silent Operation: Rigid frame with rubber mountings

TECHNICAL SPECIFICATIONS

SWEEP	POWER INPUT	SPEED	AIR DELIVERY	PHASE	CURRENT	NOISE LEVEL
450 mm	350 W	1400 r/min	5700 m³/h	1 Phase	1.5 A	70 dB – 75 dB

DIMENSIONAL SPECIFICATIONS

Sweep	Ø H mm	X mm	YSQ mm	Ø S mm
450 mm	10.5 mm	550 mm	440 mm	485 mm

General tolerance of +- 5 mm

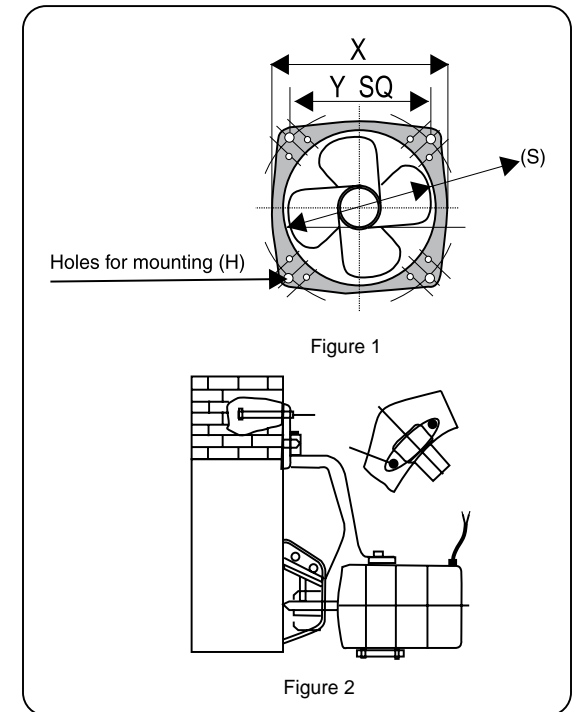

Figure 1

Figure 2

Tolerance on ratings (As per IS 2312-1967)

Speed	-5% to +10%
Power	+10%
Air Delivery	-10%

At 230 V, 1 Phase, 50 Hz AC
or 400 V, 3 Phase, 50 Hz AC





Grey

TURBO FORCE PLUS

HEAVY DUTY EXHAUST FAN



Double Ball Bearing



- WideVolt™ Motor – Ensures reliable operation across a wide voltage range (150 V – 265 V)
- IS 302: Safety Standard
- IP 55: Strong protection against dust and low-pressure water jets
- Heavy Duty Motor: Long lasting Performance for Industrial Usage
- Double Ball Bearing: Noiseless Operation
- Aerodynamically balanced impellers & blade: Smooth & vibration-free operation
- Silent Operation: Rigid frame with rubber mountings

TECHNICAL SPECIFICATIONS

SWEEP	POWER INPUT	SPEED	AIR DELIVERY	PHASE	CURRENT	NOISE LEVEL
450 mm	300 W	1400 r/min	5700 m ³ /h	1 Phase	1.4 A	70 dB – 75 dB

DIMENSIONAL SPECIFICATIONS

Sweep	Ø H mm	X mm	YSQ mm	Ø S mm
450 mm	10.5 mm	550 mm	442 mm	483 mm

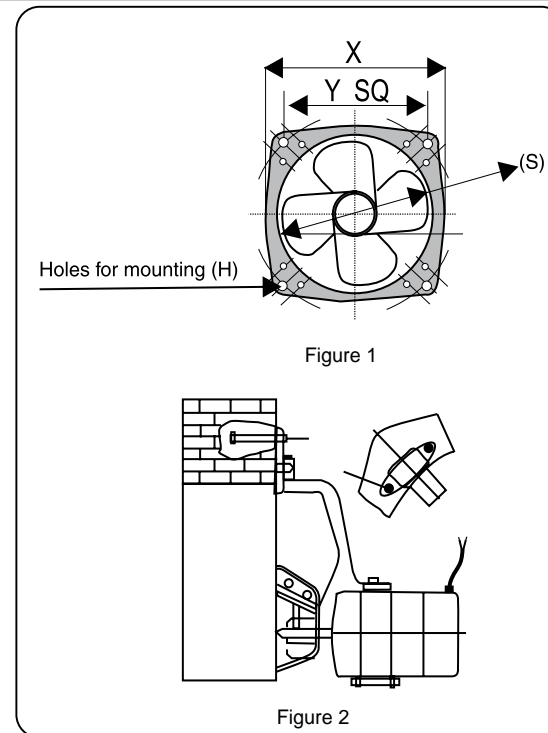

Holes for mounting (H)

Tolerance on ratings
 Speed -5% to +10%
 Power +10%
 Air Delivery -10%

At 230 V, 1 Phase, 50 Hz AC
 or 400 V, 3 Phase, 50 Hz AC



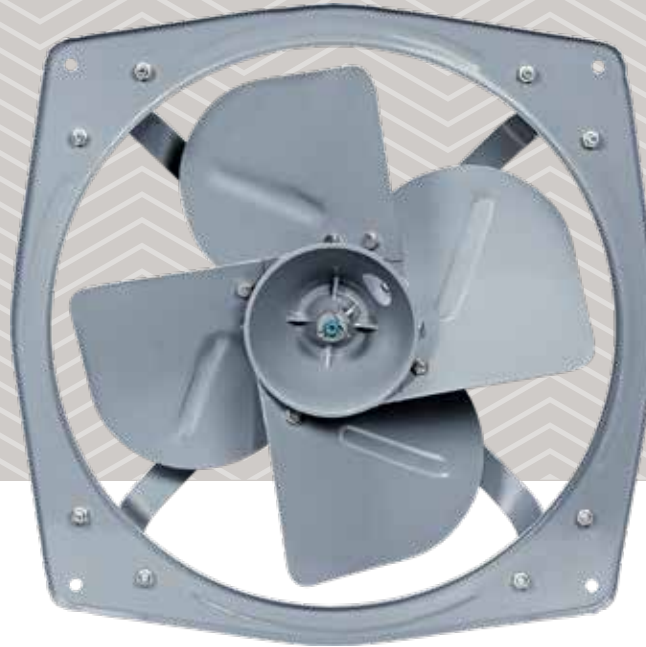

Grey

TURBO FORCE 3 PHASE HEAVY DUTY EXHAUST FAN



Double Ball Bearing



- IS 2312 for Performance plus Safety Standard with constant Air Delivery
- IP 55 for Strong protection against dust and low-pressure water jets
- Heavy Duty Motor for Long lasting Performance for Industrial Usage
- Double Ball Bearing provides Noiseless Operation
- WideVolt™ Motor ensures reliable operation across wide voltage range (150 V – 265 V)
- Aerodynamically balanced impellers & blades for Smooth & vibration-free operation
- Rigid frame with rubber mountings provides Silent Operation

DIMENSIONAL SPECIFICATIONS

SWEEP	∅ H mm	X mm	YSQ mm	∅ S mm
380 mm H.D. Exhaust Fan	10.5 mm	462 mm	373 mm	401 mm
450 mm H.D. Exhaust Fan	10.5 mm	550 mm	442 mm	483 mm
600 mm H.D. Exhaust Fan	10.5 mm	718 mm	603 mm	635 mm

TECHNICAL SPECIFICATIONS

SWEEP	PHASE	SPEED	POWER INPUT	CURRENT	AIR DELIVERY	NOISE LEVEL
380 mm	3 Phase	1400 r/min	170 W	0.4 A	3700 m ³ /h	65 dB - 70 dB
450 mm	3 Phase	1400 r/min	370 W	0.82 A	6800 m ³ /h	75 dB - 80 dB
600 mm	3 Phase	900 r/min	500 W	0.95 A	10520 m ³ /h	70 dB - 75 dB

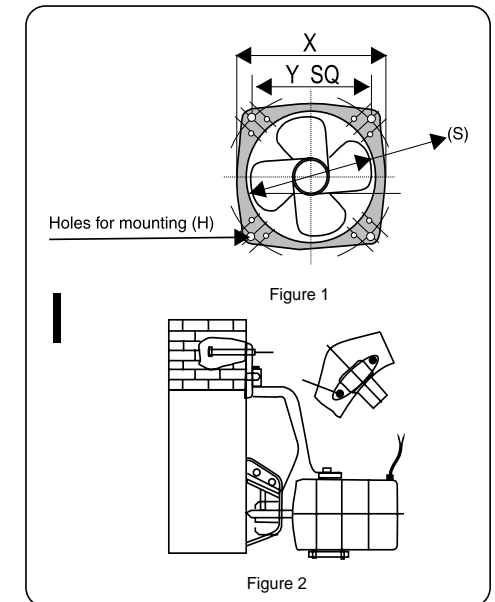

Tolerance on ratings (As per IS 2312-1967)
 Speed -5% to +10%
 Power +10%
 Air Delivery -10%

At 230 V, 1 Phase, 50 Hz AC
 or 400 V, 3 Phase, 50 Hz AC





TURBO FORCE

WALL AIR CIRCULATOR FAN



Double Ball Bearing



- Aerodynamically designed blades for higher air delivery and minimal noise levels
- Double 'Z' shielded ball bearings for longer life
- Indexable to different positions up to 15°
- Oscillation up to 90° for total flexibility
- Sturdy brazed wire guards with powder coating ensures corrosion resistance
- Generally conforming to IS: 2997-1964 standards

DIMENSIONAL SPECIFICATIONS

SWEEP	A	B	C	D	E	G1	G2	H
450 mm	500 mm	145 mm	590 mm	200 mm	565 mm	84 mm	108 mm	157 mm
600 mm	670 mm	166 mm	585 mm	185 mm	680 mm	150 mm	120 mm	170 mm
750 mm	840 mm	176 mm	660 mm	185 mm	680 mm	150 mm	120 mm	170 mm

TECHNICAL SPECIFICATIONS

SWEEP	RATED VOLTAGE	FREQUENCY	POWER INPUT	SPEED	PHASE	AIR DELIVERY	NO. OF BLADES	NO. OF SPEEDS	NOISE LEVEL
450 mm Wall	230 V	50 Hz	100 W	1440 r/min	1 Phase	150 m ³ /min	3 N	3	62 dB
600 mm Wall	230 V	50 Hz	180 W	1440 r/min	1 Phase	280 m ³ /min	3 N	1	72 dB
750 mm Wall	230 V	50 Hz	235 W	1400 r/min	1 Phase	300 m ³ /min	3 N	1	75 dB



Grey

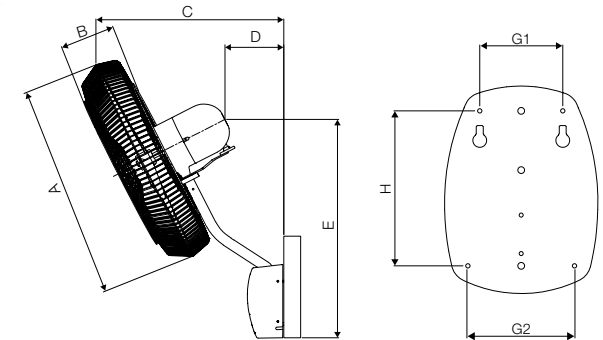

Air delivery measurement at a distance of 6 times blade sweep from the fan. Built-in regulators available only for 450 mm sweep. Conforming to IS: 2997-1964.

Tolerance on ratings (As per IS 2997-1964)
 Speed -10%
 Power +10%
 Air Delivery -10%



TURBO FORCE XL

WALL AIR CIRCULATOR FAN



Double Ball Bearing



- WideVolt™ Motor ensures reliable operation across wide voltage range (150 V – 265 V)
- Pressure Die-Cast Blades for Sturdy design and high air delivery
- Double Ball Bearings enhances durability and extends motor life
- 90° Oscillation provides complete flexibility for wider air coverage
- Sturdy Brazed Wire Guards and Powder-coated finish for corrosion resistance
- Generally conforming to IS: 2997-1964 standards



Grey



SWEEP	POWER INPUT	SPEED	AIR DELIVERY
600 mm	180 W	1400 r/min	280 m ³ /min



TURBO FORCE

PEDESTAL AIR CIRCULATOR FAN



Double Ball Bearing



THERMAL OVERLOAD PROTECTION MOTORS



100% COPPER WIRE WINDING MOTOR

- Aerodynamically designed blades for higher air delivery and minimal noise levels
- Double 'Z' shielded ball bearings for longer life
- Oscillation up to 90° for total flexibility
- Sturdy brazed wire guards with powder coating ensures corrosion resistance
- Generally conforming to IS: 2997-1964 standards

DIMENSIONAL SPECIFICATIONS

SWEEP	A	B	C	D	E	F	
						MINIMUM	MAXIMUM
450 mm	500 mm	145 mm	365 mm	785 mm	450 mm	1290 mm	1430 mm
600 mm	670 mm	166 mm	390 mm	1150 mm	585 mm	1340 mm	1650 mm
750 mm	840 mm	176 mm	412 mm	1150 mm	705 mm	1340 mm	1650 mm

TECHNICAL SPECIFICATIONS

SWEEP	RATED VOLTAGE	FREQUENCY	POWER INPUT	SPEED	PHASE	AIR DELIVERY	NO. OF BLADES	NO. OF SPEEDS	NOISE LEVEL
450 mm Pedestal	230 V	50 Hz	100 W	1440 r/min	1 Phase	150 m ³ /min	3 N	3	62 dB
600 mm Pedestal	230 V	50 Hz	180 W	1440 r/min	1 Phase	280 m ³ /min	3 N	1	72 dB
750 mm Pedestal	230 V	50 Hz	235 W	1400 r/min	1 Phase	300 m ³ /min	3 N	1	75 dB

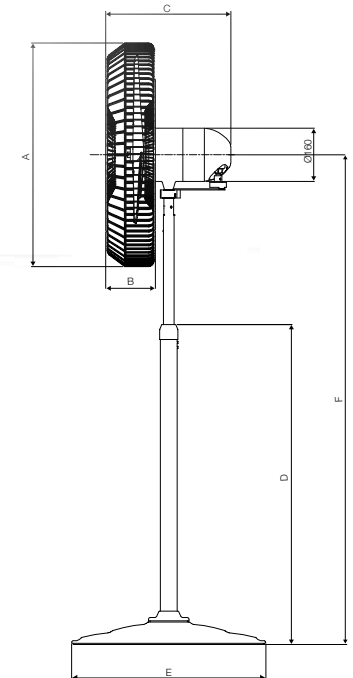

Air delivery measurement at a distance of 6 times blade sweep from the fan.
 Built-in regulators available only for 450 mm sweep.
 Conforming to IS: 2997-1964.
 Tolerance on ratings (As per IS 2997-1964)
 Speed -10%
 Power +10%
 Air Delivery -10%

BLDC MODELS REMOTE OPERATION

S. No.	Features	APP* / Remote Control (*for IoT models only)	Momenta UL* (IoT)	Crista UL* (IoT)	Florette UL Smart Sense Albus UL Smart Sense	Stealth Voice	Florette Crista	Stealth Air Stealth Neo Stealth Prime Amaya Stealth Slim Inveno LX
1	Signal Type	Remote	RF	RF	RF	RF	RF	RF
2	All ON / OFF	Remote / App	√	√	√	X	X	X
3	Fan ON/OFF	Remote / App	√	√	√	√	√	√
4	Speed Control 1, 2, 3, 4, 5	Remote / App	√	√	√	√	√	√
5	Smart Sense	Remote	X	X	√	X	X	X
6	Breeze Mode	Remote / App	√	√	√	√	√	√
	Mop Mode	Remote / App	√	X	√	√	√	√
	Sleep Mode	Remote / App	√	√	√	√	√	√
	Boost Mode	Remote / App	X	X	X	X	X	X
7	Timer	Remote / App	2 h, 4 h, 6 h, 8 h					
8	Reverse	Remote	X	X	√	√	√	√
9	Light ON/OFF	Remote / App	√	√	√	X	X	X
10	Light Color Changing	Remote / App	Cool, Natural, Warm	Cool, Natural, Warm	Cool, Natural, Warm	X	X	X
11	Light Intensity	Remote / App	√	√	√	X	X	X
12	IoT Reset	Remote	√	√	X	X	X	X
13	Voice Control	Voice Module	X	X	X	√	X	X
14	Alexa / Google	App	√	√	X	X	X	X
15	Grouping	App	√	√	X	X	X	X
16	Scheduling	App	√	√	X	X	X	X
17	IoT / BLE Local Control	App	√	√	X	X	X	X
18	Regulator Compatability	-	X	X	X	X	X	X
19	Heater	Remote	X	X	X	X	X	X

BLDC MODELS REMOTE OPERATION

Elio Elio Prime	Epic	Epic Voice	Neon	Enticer Prime	Efficiencia Neo Plus	Elio Plus Epic Plus	Epic Signia Smart	Cera UL Epic LED	Florette All Weather UL	Stealth Air UL Stealth Slim UL Neoma	Epic UL Neon UL
RF	RF	RF	RF	RF	RF	RF	RF	RF	RF	RF	RF
X	X	X	X	X	X	X	X	X	√	√	√
√	√	√	√	√	√	√	√	√	√	√	√
√	√	√	√	√	√	√	√	√	√	√	√
X	X	X	X	X	X	X	X	X	X	X	X
√	√	√	√	√	√	√	√	√	√	√	√
√	√	√	√	√	√	√	√	√	√	√	√
√	√	√	√	√	√	√	√	√	√	√	√
√	√	√	√	X	√	√	√	√	X	X	√
2 h, 4 h, 6 h, 8 h											
√	√	√	√	√	√	√	√	√	√	√	√
X	X	X	X	X	X	X	√	√	√	√	√
X	X	X	X	X	X	X	X	X	Cool, Natural, Warm	Cool, Natural, Warm	Cool, Natural, Warm
X	X	X	X	X	X	X	X	X	√	√	√
X	X	X	X	X	X	X	X	X	X	X	X
X	X	√	X	X	X	X	X	X	X	X	X
X	X	X	X	X	X	X	X	X	X	X	X
X	X	X	X	X	X	X	√	X	X	X	X
X	X	X	X	X	X	X	√	X	X	X	X
X	X	X	X	X	X	X	√	X	X	X	X
X	X	X	X	√	X	√	X	X	X	X	X
X	X	X	X	X	X	X	X	X	√	X	X

RF Remote for all direction sensing



Wi-Fi Reset

Reset



All ON/OFF



1,2,3,4,5 Fan Speed

Intensity Up/Down



Fan ON/OFF

Color Mode

Colour



Breeze Mode

It enables to feel refreshing breeze with automatic speed variation

Preset Timer

Timer



Mop Mode

It helps to dry wet floor post mopping swiftly

Timer Setting upto 8 hours
2 h, 4 h, 6 h, 8 h

Timer



Sleep Mode

It provides ideal sleep by reducing fan speed after specified intervals

Light ON/OFF

Light



Boost Mode

It provides automatic speed variations after every 25 seconds - 30 seconds

Mode Control

Mode

Features may vary from model to model.

Wide range of innovative products in Havells categories



Fans



Small Domestic Appliances



Kitchen Appliances



Consumer Lighting



Water Heater



Water Purifiers



Personal Grooming



Air Coolers



Switches & Automation



Accessories



Wire & Cables



Solar



Building Circuit Protection



Pumps & Motors



Industrial Products



SCAN TO
KNOW MORE

Havells India Ltd.

QRG Towers, 2D, Sector -126, Expressway, Noida - 201 304 (UP), Ph. +91-120-3331000

CIN - L31900DL1983PLC016304.

Copyright Subsists. Imitation of trade dress, graphics and color scheme of this document is a punishable offence.

"Actual products may vary in colour, design, description and colour combination etc. Although every effort has been made to ensure accuracy in the compilation of the technical detail within this publication. Specifications & performance data are constantly changing."

All trademarks used herein are property of their respective owners. Any use of third party trademarks is for identification purpose only and does not imply endorsement

Havells India Ltd.

QRG Towers, 2D, Sector -126, Expressway, Noida - 201 304 (UP), Ph. +91-120-3331000

CIN - L31900DL1983PLC016304.

Copyright Subsists. Imitation of trade dress, graphics and color scheme of this document is a punishable offence.

“Actual products may vary in colour, design, description and colour combination etc. Although every effort has been made to ensure accuracy in the compilation of the technical detail within this publication. Specifications & performance data are constantly changing.”

All trademarks used herein are property of their respective owners. Any use of third party trademarks is for identification purpose only and does not imply endorsement



**SCAN TO
KNOW MORE**